

Temescal

CV-12SLX USER MANUAL



Revision C, April 2016

Temescal, a division of Ferrotec (USA) Corporation
4569-C Las Positas Road, Livermore, CA 94551
Tel: 1-800-522-1215; Fax: 925-449-4096

Revision History

0101-8292-0

Rev.	Change Description	Reason/Application	Date	Appvd.
A	First published version of CV-12SLX User Manual, based on the CV-12SLX Technical Manual, Rev. D.	Applies to all CV-12SLX units, with HV power supplies with PNs 0620-1115-0 (for 208-volt units) and 0620-1125-0 (for 400-volt units)	March 2014	IA
B	On p. 2-2, corrected PNs of 2-gun power modules from 0620-1115-0 to 0620-1115 for 208-V models and from 0620-1125-0 to 0620-1125-1 for 400-V models.	Power module PNs initially entered incorrectly	Aug. 2014	IA
C	Changed all occurrences of 0620-9654-0 to 0620-9654-1 and all occurrences of 6024-6112-1 to 0620-8684-1.	Pursuant to PN change implemented by ECN 12185.	April 2016	IA

Table of Contents

<u>Section Number and Title</u>	<u>Page Number</u>
1 Introduction to the CV-12SLX.....	1-1
1.1 Product Description	1-1
1.2 CV-12SLX HVPS Description and Specifications.....	1-1
1.3 Filament Power Supply Description and Specifications	1-2
1.4 Miscellaneous Hardware and Interconnection Cables	1-3
1.5 TemEBeam EBC Integrated Controller	1-3
2 Installation	2-1
2.1 Section Overview	2-1
2.2 List of Components and Cables Supplied with the Unit.....	2-2
2.3 Rack Mounting the Power Module (HVPS).....	2-2
2.4 Mounting the Filament Power Supply Module(s)	2-3
2.5 Grounding Requirements	2-4
2.6 Cable Installation	2-9
3 Power Supply Operation	3-1
3.1 Section Overview	3-1
3.2 HVPS Front Panel Controls and Indicators.....	3-1
3.3 Switches and LEDs on the FPS Front Panel	3-2
3.4 Power-Up Procedure.....	3-3
3.5 Control of Power Supply from TemEBeam EBC Integrated Controller.....	3-3
3.6 Control of Power Supply by a PLC-Based System Controller	3-8
3.7 Responding to Fault Conditions	3-11
4 Theory of Operation	4-1
4.1 Section Overview	4-1
4.2 HVPS Theory of Operation	4-1
4.3 FPS Theory of Operation.....	4-4
5 Troubleshooting	5-1
5.1 Section Overview	5-1
5.2 HVPS Front Panel LEDs.....	5-1
5.3 Ishikawa Diagrams.....	5-6
5.4 Troubleshooting Procedures.....	5-15
5.5 FPS Fuse Replacement Procedure	5-30
5.6 Suggested Spare Parts	5-31
Appendix A: Pinout Table for Power Module Diagnostic Port (HVPS J3)	A-1

List of Illustrations

Figure Number and Title	Page Number
Figure 1-1 CV-12SLX HVPS Front Panel.....	1-1
Figure 1-2 Filament Power Supply Front Panel	1-2
Figure 1-3 EBC Main Control Unit and Hand-Held Controller	1-3
Figure 2-1 Mounting Hole Pattern for FPS Module(s).....	2-4
Figure 2-2 Facility Low Impedance Grounding Requirements.....	2-5
Figure 2-3 System Low Impedance Grounding Requirements	2-6
Figure 2-4 Rear Panel of Single Gun CV-12SLX HVPS	2-7
Figure 2-5 Rear Panel of Dual Gun CV-12SLX HVPS	2-7
Figure 2-6 Grounding Studs on FPS Front Panel	2-8
Figure 2-7 Input Power Connections to 208-Volt HVPS Units	2-10
Figure 2-8 Input Power Connections to 400-Volt HVPS Units	2-10
Figure 2-9 Input Power and HV Connections on FPS Front Panel	2-11
Figure 2-10 Removing the FPS Conduit Panel.....	2-12
Figure 2-11 Conduit Properly Secured to FPS Conduit Panel.....	2-12
Figure 2-12 HV Output Cables Secured to Studs inside FPS.....	2-13
Figure 2-13 HV Conduit Bracket Properly Installed on HV Feedthrough	2-13
Figure 2-14 HV Conduit Properly Secured to Bracket.....	2-14
Figure 2-15 Control/Data Cable Connections on FPS Front Panel	2-14
Figure 2-16 System I/Os Exchanged via HVPS Rear Panel Connector J4 and the HVPS I/O Cable (PN 0620-6682-0).....	2-16
Figure 2-17 System I/Os Exchanged via FPS Front Panel Connector J101 and the FPS I/O Cable (PN 0620-6672-2)	2-18
Figure 3-1 CV-12SLX HVPS Front Panel.....	3-1
Figure 3-2 Filament Power Supply Front Panel	3-2
Figure 3-3 EBC's Operations>E-Beam Screen when Beam Is Off	3-4
Figure 3-4 Operations>E-Beam Screen, Beam On at 0.0 mA.....	3-4
Figure 3-5 Operations>E-Beam Screen when Gun is On and HV is Off.....	3-5
Figure 3-6 Operations E-Beam Screen with Numeric Keypad Displayed	3-5
Figure 3-7 Operations>E-Beam Screen, Beam on at 5% Power	3-6
Figure 3-8 The EBC's Diagnostics Screen	3-6
Figure 3-9 Remote Controller's LOCAL Screen, Menu 1 Selected, Beam and Sweep Off.....	3-8
Figure 3-10 HVPS Front Panel LEDs: HVPS Powered Up in Nominal State, with HV and FPS Off.....	3-9
Figure 3-11 HVPS Front Panel LEDs when Subthreshold Arcing is Occurring.....	3-12
Figure 3-12 HVPS Front Panel LEDs when a Latched OUTPUT ARCING Fault Has Occurred	3-12
Figure 4-1 Single-Gun CV-12SLX HVPS Rear Panel.....	4-1
Figure 4-2 Dual-Gun CV-12SLX HVPS Rear Panel.....	4-2
Figure 4-3 Filament Power Supply (FPS) Module.....	4-4
Figure 4-4 Component Location in Standard FPS Units (PN 0620-6604-0 and -1).....	4-5
Figure 4-5 Top Level Block Diagram for Standard FPS Units (PN 0620-6604-0 and -1)	4-6
Figure 4-6 Component Location in FPS Units with PN 0620-6604-2.....	4-7
Figure 4-7 Top Level Block Diagram for FPS Units with PN 0620-6604-2	4-7
Figure 4-8 Filament Supply PCB Overview Block Diagram.....	4-8
Figure 4-9 Block Diagram of Filament Supply PCB Control and Power Circuits	4-10
Figure 4-10 Emission Current Ramp Circuit.....	4-11
Figure 4-11 Autobias Circuit Block Diagram	4-12
Figure 5-1 HVPS Front Panel LEDs.....	5-2
Figure 5-2 Status Indicator LEDs	5-2
Figure 5-3 Sub-Threshold Arcing: Arc/Out Of Regulation and Output Arcing LEDs	5-3
Figure 5-4 Filament Load Fault and Filament Power LEDs	5-3
Figure 5-5 HVPS Front Panel LEDs with Latching Fault LEDs Outlined	5-4
Figure 5-6 Interlocks OK and Rail Undervoltage LEDs	5-4
Figure 5-7 HV Overcurrent and HV Overvoltage LEDs	5-5
Figure 5-8 Setpoint Overvoltage and Output Arcing LEDs.....	5-5
Figure 5-9 Inverter Overload and Overtemperature LEDs.....	5-5
Figure 5-10 Aux Supply Low and External Control Fault LEDs.....	5-6

List of Illustrations (Continued)

<u>Figure Number and Title</u>	<u>Page Number</u>
Ishikawa Diagram #2: Interlock Fault.....	5-7
Ishikawa Diagram #3: No Beam After HV and Gun Are Switched ON.....	5-8
Ishikawa Diagram #4: HV Output Unstable.....	5-8
Ishikawa Diagram #5: <i>HV Out of Regulation</i> LED Lights Frequently.....	5-9
Ishikawa Diagram #6: <i>Arc/Out of Regulation</i> LED Lights Excessively for the Material/Application	5-9
Ishikawa Diagram #7: Rail Undervoltage Fault.....	5-10
Ishikawa Diagram #8: HV Overcurrent Fault.....	5-10
Ishikawa Diagram #9: HV Overvoltage Fault.....	5-11
Ishikawa Diagram #10: Setpoint Overvoltage Fault	5-11
Ishikawa Diagram #11: Output Arcing Fault.....	5-12
Ishikawa Diagram #12: Overtemperature Fault.....	5-12
Ishikawa Diagram #13: Aux Power Supply Low Fault.....	5-13
Ishikawa Diagram #14: External Control Fault	5-13
Ishikawa Diagram #15: Filament Load Fault	5-14
Ishikawa Diagram #16: Simultaneous Filament Load Fault + Filament Power Fault	5-14
Ishikawa Diagram #17: Emission Current Unstable.....	5-15
Figure 5-11 Prying Open the Fuse Block Cover on FPS Front Panel	5-30
Figure 5-12 Extracting the Fuse Block from the FPS.....	5-30
Figure 5-13 Fuse Block Removed from FPS	5-31

List of Tables

<u>Table Number and Title</u>	<u>Page Number</u>
Table 2-1 Descriptions of I/Os Exchanged via HVPS Rear Panel Connector J4 and HVPS I/O Cable (PN 0620-6682-0) ...	2-17
Table 2-2 Descriptions of I/Os Exchanged via FPS Rear Panel Connector J101 and FPS I/O Cable (PN 0620-6672-2) ...	2-19
Table 5-1 No Input Power Indicated.....	5-16
Table 5-2 One or More Interlocks Not Made.....	5-17
Table 5-3 General Condition: HVPS Powered Up But Fails to Achieve HV Ready State.....	5-17
Table 5-4 HVPS and FPS Are Powered Up but GUN READY State Not Achieved/Confirmed.....	5-18
Table 6-5 HVPS Powered Up but HV Does Not Switch On When Commanded To Do So.....	5-18
Table 5-6 FPS Powered Up but Gun Does Not Switch On When Commanded To Do So	5-19
Table 5-7 No Filament Current After GUN ON State Is Achieved.....	5-19
Table 5-8 No Beam Emitted After HV and Gun Are Switched On.....	5-20
Table 6-9 HV Output Unstable	5-20
Table 5-10 Filament Current Out Of Regulation	5-21
Table 5-11 HVPS ARC/OUT OF REGULATION LED Flashes Excessively	5-21
Table 5-12 HVPS RAIL UNDERVOLTAGE LED Lights Red	5-22
Table 5-13 HVPS HV OVERCURRENT LED Lights Red	5-23
Table 5-14 HVPS HV OVERVOLTAGE LED Lights Red	5-24
Table 5-15 HVPS SETPOINT OVERVOLTAGE LED lights red.....	5-25
Table 5-16 HVPS OUTPUT ARCING LED lights red	5-25
Table 5-17 HVPS INVERTER OVERLOAD LED lights red.....	5-26
Table 5-18 HVPS OVERTEMPERATURE LED lights red	5-27
Table 5-19 Fan fails to rotate when HVPS is powered up	5-27
Table 5-20 HVPS AUXILIARY SUPPLY LOW LED lights red.....	5-27
Table 5-21 HVPS EXTERNAL CONTROL FAULT LED lights red.....	5-28
Table 5-22 HVPS FILAMENT LOAD FAULT LED lights red	5-28
Table 5-23 HV Is Switched On but FPS Front Panel HIGH VOLTAGE ON LED Fails To Light	5-28
Table 5-24 FPS #1 Is Switched On but Its POWER ON LED Fails To Light	5-29
Table 5-25 FPS #2 Is Switched On but Its POWER ON LED Fails To Light	5-29
Table 5-26 Suggested Spare Parts for 208-Volt Units	5-31
Table 5-27 Suggested Spare Parts for 400-Volt Units	5-32

Terms and Conditions

1. Delivery. Unless otherwise stated, shipments of Ferrotec Temescal Electron Beam Gun and Systems products quoted and/or produced at the Livermore, CA factory site will be made Ex-Works, Livermore, CA Incoterms. Shipping date as are approximate and are based on conditions at the time of acceptance and prompt receipt of all necessary information from the Buyer. Pro- Rata payments shall become due as shipments are made. Items held of Buyer shall be at the risk and expense of the Buyer.

2. Title.

- A. This subsection applies in jurisdictions where the laws provides a purchase-money security interest, or similar rights, in favor of the seller, including but not limited to the U.S., Canada, and Mexico: Title and risk of loss or damage passes to Buyer when the goods are put into possession of the freight carrier for delivery to Buyer. Seller retains a security interest in the goods to ensure payment in full. Buyer agrees not to take any action with respect to the goods that would interfere with Seller's security interest until the goods are fully paid for.
- B. This sub-section applies in all other jurisdictions: Risk of loss or damage passes to Buyer when the goods are put into possession of the freight carrier for delivery to Buyer. Seller retains sufficient title in the goods to ensure the goods are fully paid for. Buyer agrees not to take any action with respect to the goods that would interfere with Seller's title until the goods are fully paid for.

3. Delays in Deliveries. Seller shall not be liable for failure to fill any order when due to: fires; riots; strikes; freight embargoes or transportation delays; shortage of labor; inability to secure fuel, material, supplies or power at current price or on account of shortages thereof; acts of God or of the public enemy; any existing or future laws or acts of the federal or of any state or local government (including specifically but not exclusively any orders, rules or regulations issued by an official or agency of any such government) affecting the conduct of Seller's business with which Seller in its judgment and discretion deems it advisable to comply as a legal or patriotic duty; or to any cause beyond Seller's reasonable control. Seller is not liable for damages attributed to delays in delivery.

4. Taxes. Prices quoted herein shall be subject to an additional charge to cover any existing or future Manufacturers, Sales, Use, Value Added or similar tax which may be applicable and any administrative costs for required governmental permits, inspections and the life.

5. Special Order Equipment. Where buyer shall furnish special order equipment, Buyer shall bear the cost of alterations made thereon, except such as Seller may make for its own convenience. Buyer shall furnish drawings and specific information as to variations permissible between equipment and drawings. Shipping and crating charges on said equipment to and from Seller's facilities shall be borne by buyer. Seller shall have no responsibility for loss or damage to said equipment, except when due to careless handling or negligence on the part of Seller. Cost of insurance on special orders will be borne by buyer, and same are held at Buyer's risk.

6. Seller's Warranty. Seller's standard published warranty in effect at the time of shipment for the particular product shall apply. THIS WARRANTY IS EXCLUSIVE AND IS IN LIEU OF ALL OTHER WARRANTIES, EXPRESS, IMPLIED OR STATUTORY, INCLUDING THE WARRANTIES OF MERCHANTABILITY OR FITNESS FOR A PARTICULAR PURPOSE. Seller's liability shall not in any case exceed the cost of repair or replacement of any defective product as stated in the warranty and upon expiration of the warranty period all such liability shall terminate. Seller shall in no event be liable for consequential damages of any kind.

7. Changes and Acceptance. Any changes in drawings specifications or in their Terms and Conditions will require Seller's written approval before they become binding.

8. Cancellations. The following schedule of cancellation charges shall apply:

A. Cancellations:

i. For custom/modified products:

<u>When cancellation notice received:</u>	<u>Charge is:</u>
1-30 days prior to shipment	100% of product sales price
31-60 days prior to shipment	75% of product sales price
61-90 days prior to shipment	50% of product sales price
91 days or more prior to shipment	10% of product sales price

ii. For standard products: To be negotiated

B. Reschedules:

- i. For completed custom/modified product 1.5% per month x sales price of product rescheduled
- ii. Incomplete custom/modified product, parts 1.5% per month x sales price of rescheduled products which are stocked or ordered.
- iii. Restocking: Only standard products may be restocked. 25% of dollar value returned to Seller's stock, plus all freight charges. All restocking is subject to Seller's approval and inspection.

9. Payment. The terms of payment of items quoted herein shall be: cash in advance or net 30 upon credit approval unless otherwise agreed in writing. If at any time, in the judgment of the Seller, Buyer's credit shall be impaired, Seller shall have the right to demand immediate cash payment and to refuse to make delivery except against payment therefore in cash.

10. No implied License. The sale of any product or material quoted herein does not give or imply any right or license to buyer to analyze or manufacture such product or material or to claim Buyer is an authorized re-seller of such material.

11. Export Licenses. Items quoted herein may constitute a controlled commodity requiring export licenses from the U.S. Department of Commerce prior to transshipment. Buyer shall be responsible for obtaining any such licenses required.

12. Exclusive Statement. The terms and conditions contained in Seller's Order Acknowledgement will be the complete and exclusive statement of the terms of agreement between the parties. If the terms of said Acknowledgement differ in any way from the terms of Buyer's order, the provisions of said Acknowledgement shall prevail and be controlling.

13. State Laws. This contract shall be governed in all respects by the laws of the State of New Hampshire and the State of California.

14. This contract is governed by Incoterms 2010.

FERROTEC (USA) CORPORATION'S ACCEPTANCE OF THE REFERENCED PURCHASE ORDER IS EXPRESSLY MADE CONDITIONAL ON THE PARTY'S ASSENT (WHO SUBMITTED THE REFERENCED PURCHASE ORDER) TO FERROTEC'S ADDITIONAL OR DIFFERENT TERMS IN THIS ORDER ACKNOWLEDGEMENT. IF NO ANSWER IS RECEIVED FROM THE PARTY SUBMITTING THE REFERENCED PURCHASE ORDER WITHIN A REASONABLE TIME AFTER RECEIPT OF THIS ORDER ACKNOWLEDGEMENT, IT WILL BE ASSUMED THAT THEIR INCLUSION HAS BEEN ASSENTED TO.

Limited Warranty

1. **Parties Covered.** This limited warranty is given by Ferrotec (USA) Corporation hereinafter called the “Warrantor” to the buyer of the above described item(s) and extends to Buyer only and is not transferable to nor enforceable by any transferee, subsequent purchaser or successor of buyer.
2. **Term of Limited Warranty.** The term of this limited warranty shall be one year from the date of shipment of the above items(s). Warrantor shall not have liability or responsibility under this limited warranty or under any warranties implied by law or otherwise, for defects ensuring or claims asserted after the expiration of the term of this Limited Warranty.
2. **Limitations of warranties.** The only express or implied warranties of Warrantor are those expressed in this instrument.
 - A. WITHOUT LIMITATION, WARRANTOR HEREBY DISCLAIMS ANY WARRANTY OF MERCHANTABILITY OR FITNESS FOR A PARTICULAR PURPOSE. THERE ARE NO WARRANTIES WHICH EXTEND BEYOND THE EXPRESS WARRANTIES SET FORTH HERIN. THE TERM OF ANY WARRANTY OR WARRANTOR IMPLIED BY LAW SHALL END ON THE TERMINATION DATE OF THIS LIMITED WARRANTY SPECIFIED IN SECTION 2.
 - B. Warranty duration for out of warranty items repaired by Ferrotec shall be ninety (90) days from date of shipment post repair “Ex-works”.
4. **Warranty Coverage.** Subject to the exclusions set forth in Section 5, the item(s) described above is/(are) warranted against defects in material or workmanship. Warrantor shall, at its option, repair or replace at its cost any defective item during the warranty period. Warrantor may repair the item at any of its worldwide service locations.
5. **Exclusions from coverage.** Warrantor expressly disclaims responsibility for any of the following, each of which is expressly EXCLUDED from this limited warranty.
 - A. Ordinary wear and tear, damage or defects due to abuse, misuse, failure to use according to instruction, or exposure to temperatures and conditions in excess of those referred to in the Notes and instructions delivered herewith. If different operating temperatures or conditions are specified in documentation specific to your product, these supersede those on the enclosed Notes and instructions.
 - B. Damage or defects caused by Acts of God, the elements, natural disasters, or by the wrongful or negligent act or omission of anyone other than the Warrantor.
 - C. Damage or defects to any product disassembled, modified, repaired or replaced by any party other than the warrantor or its expressed authorized representative, whether or not damage was caused by said disassembly or modification.
 - D. Incidental, consequential or special damages of any kind.
6. **Claims Procedure.** Buyer shall promptly notify warrantor in writing of a claim under this Limited Warranty or any warranty implied by law. Buyer is responsible for freight charges for shipment of product to Warrantor. Warrantor will pay for the freight charges for shipment of product back to Buyer where the product is found to be defective.
7. **Severability: No Waiver.** In the event any of the provisions hereof shall be invalid, the remainder of the provisions of this Limited Warranty shall remain in full force and effect. No waiver by Warrantor of the provisions hereof at any time shall constitute a waiver of any such provisions at any subsequent time or of any other provisions at any time.

Safety Instructions for Operating and Service Personnel

Operators and service personnel should always wear safety glasses. Operators shall not enter areas intended for service access only. Only experienced service personnel should enter such areas, and only after taking the preliminary precautions described in paragraphs 1 through 6 below.

DANGER

Potentially lethal voltages may exist within this unit, even with the line power switched off. Service should only be attempted by qualified personnel. Failure to observe all safety precautions may result in personal injury.

This component is designed to operate as part of a system containing high-voltage equipment. Observe the precautions described below when servicing this system, especially when servicing components where high voltages may be present.

1. Before servicing or operating this equipment, read all the component manuals supplied with the system, paying special attention to safety instructions.
2. Post HIGH VOLTAGE WARNING signs in conspicuous locations within the service area.
3. Remove rings, watches, bracelets, and any other metal jewelry before working around high voltage.
4. DO NOT WORK ALONE!
5. Be sure that all equipment is connected to a power receptacle having the correct polarity and grounding, as prescribed by the local electrical codes. Refer to the power supply portion of the documentation to determine the proper electrical ground for high-voltage components.
6. Before servicing any high-voltage component, switch off the electrical power at the component's main power switch. This switch should have a lockout feature. Lock the power off and keep the key with you while you are working on the equipment.
7. Certain electrical parts (e.g., electrolytic capacitors) hold a lethal voltage even after the power is switched off. Before entering any service area, use a grounding hook to discharge such parts. Be sure that these parts are discharged before starting any repairs.
8. DO NOT touch high-voltage leads unless power is off and a grounding hook is connected to the parts to be serviced.
9. The high-voltage components of the system should be equipped with electrical interlocks to protect personnel from injury. **DO NOT ATTEMPT TO DEFEAT, OVERRIDE, OR BYPASS THESE PROTECTIVE DEVICES!**
10. Never leave loose ends on high-voltage connections.
11. Observe the following warning if the system employs Radio Frequency (RF) power.

DANGER

RF radiation—even at modest power levels—can cause serious injury. If any of the RF components (e.g., the RF power supply, the RF matching network, or the RF electrodes or shielding inside the product chamber) are moved or changed in any way, the RF energy may be radiated outside the equipment. Monitor the equipment to assure that external RF radiation is below the levels prescribed by any and all applicable safety codes.

Special Amendment for United Kingdom Users All Electrical Power Sources: Safety Precautions

This component is designed to be used in an extra-high-voltage system. Only authorized personnel should be permitted to carry out work on this system.

Prior to any servicing, grounding hooks should be used to short out all high-voltage parts and conductors in both the vacuum system and the high-voltage power supply. Screens protecting extra-high-voltage conductors should be removed only if appropriate action has been taken to ensure that extra-high-voltage conductors are dead and cannot be reenergized inadvertently.

In addition, all personnel should be aware of:

1. The Electricity (Factories Act) Special Regulations (1908 and 1944), in particular, Regulations 18(d) and 28 of the 1980 Regulations, as amended; and
2. The employer's responsibility to set up suitable systems to safeguard the health and safety of employees, according to the Health & Safety at Work etc. Act (1974).

User Responsibility

This equipment will perform in accordance with the instructions and information contained in the user's manual and its referenced documents when such equipment is installed, operated, and maintained in compliance with such instructions. The equipment must be checked periodically. Defective equipment shall not be used. Parts that are broken, missing, plainly worn, distorted, or contaminated, shall be replaced immediately. Should such repair or replacement become necessary, a telephone or written request for service should be made to Temescal, Livermore, CA, a division of Ferrotec (USA) Corp.

The equipment, or any of its parts, shall not be altered without the prior written approval of Temescal. The user and/or purchaser of this equipment shall have the sole responsibility for any malfunction which results from improper use, faulty maintenance, damage, improper repair, or alteration by any party other than Temescal.

Guidelines And Good Practices

1. Follow applicable clean room procedures (smocks, masks, gloves, etc.).
2. Do not expose the vent and purge valves to excessive pressures. The nitrogen line regulator is factory set at 15 psi and must not be adjusted above 20 psi.
3. Prevent oil, grease, water, sweat, etc. from getting into the vacuum chamber.
4. Replace the source tray shield correctly to ensure that the ceramic parts or the high voltage feedthroughs are protected from being coated.
5. Clean all mechanical parts and seals with lint-free paper/cloth soaked with isopropyl alcohol (IPA). Dispose all IPA-exposed cleaning paper/cloth in a fireproof container, while ensuring proper safety precautions are being followed.
6. Polish scratched surfaces with Scotch-Brite, taking care not to produce any cross scratches.
7. Shaft seals are all ferromagnetic. No lubrication is required.
8. Check the chamber door's seal and sealing surfaces each time before closing it.
9. Check and clean with IPA the source tray seals and sealing surfaces each time before raising the source tray into place.
10. Train staff by competent personnel. DO NOT allow staff to operate or do maintenance and recovery work on the machine until they are trained by competent personnel.
11. Document all alarms, deviations, breakdowns, and servicings done on either a hardcopy or an electronic equipment-log system.

HEALTH HAZARD

The condensates deposited on the tank walls of a vacuum system are generally in the form of extremely fine particles. The nature, as well as the form, of the materials poses the following potential health hazards:

- a) Inhaling fine particles (powder) may cause damage to the lungs. To help prevent this, wear a protective respirator mask with fine filter that has been approved by the National Institute for Occupational Safety and Health (NIOSH) and the federal Mine Safety and Health Administration (MSHA).
- b) Some substances are toxic and inhaling them should be avoided. Take steps to ascertain whether or not the material being deposited is a known toxic substance. Refer to the Material Safety Data Sheet(s) covering the evaporant(s) in question.
- c) Certain powders (titanium, for instance) can cause flash fires when exposed to oxygen or other oxidizers. Therefore, when opening the chamber door after a deposition cycle, exercise extreme caution and allow time for the coating surface to oxidize. Breakage of some of the more reactive condensates may be hazardous, even when the above precautions are observed. In this situation, fire-protective clothing should be worn.
- d) Certain powders (platinum, for instance) are known to catalyze methyl alcohol vapors upon contact, generating heat in the process and possibly causing a fire to erupt. Therefore, never use methyl alcohol to wipe down or clean any internal tank surfaces of a vacuum system. Use isopropyl alcohol (IPA), instead. Dispose of all IPA-exposed lint-free paper/cloth into a fireproof container, while ensuring all proper safety procedures and precautions are being followed.

1 Introduction to the CV-12SLX

1.1 Product Description

The Temescal Model CV-12SLX is a 12-kW, constant voltage, high-frequency, switching electron beam power supply. Designed to power and control up to two electron beam sources, the CV-12SLX is compatible with sources featuring either permanent-magnet or electromagnetic deflection. The power supply delivers up to 10 kV at 1200 mA, making it possible to achieve substantial deposition rates in production environments. The CV-12SLX provides stable output at all voltage levels, rapid arc recovery, ease of integration, and safety and convenience for operating as well as service personnel.

The main components of CV-12SLX units are the HVPS (see Figure 1-1), the filament power supply (see Figure 1-2), and the control and high-voltage cables required to connect these components to each other and to the system's control computer.

NOTE

In systems without a PLC-based system controller, a TemEBeam™ Controller (see Figure 1-3 is a required accessory for the CV-12SLX. For additional information about the EBC, see section 1.5.

1.2 CV-12SLX HVPS Description and Specifications

Figure 1-1 shows the front panel of the CV-12SLX power module, or HVPS. For a description of its control and display features, see sections 3.2 and 5.2. For installation instructions, see section 2.3.

Figure 1-1 CV-12SLX HVPS Front Panel

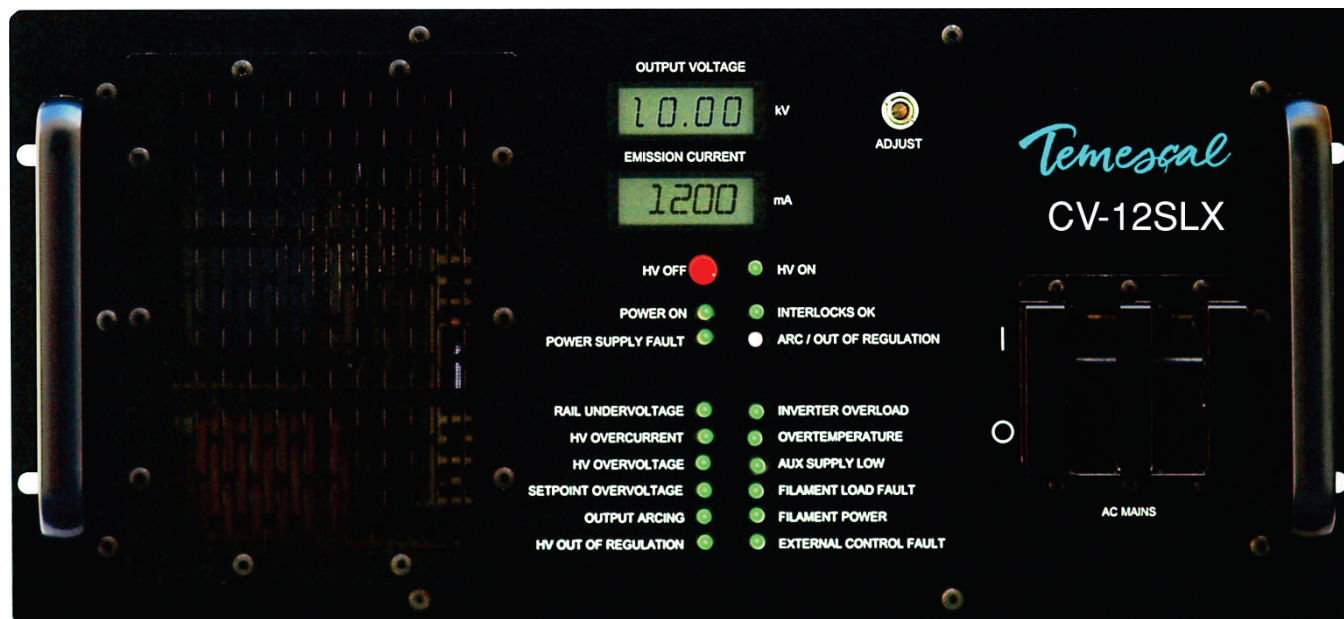

For FPS installation instructions, see section 2.4. For a description of the switches and LEDs on the FPS front panel, see section 3.3.

FPS Specifications

Dimensions: 6.5 in. H × 6.5 in. W × 11 in. D

Weight: 14 lbs.

Input Power: 208 V ac ±10%, 3.5 A, 50/60 Hz, single-phase

Power Output: 10 V ac, 50 A, 28.5 kHz (max.), single-phase

1.4 Miscellaneous Hardware and Interconnection Cables

For a complete list of the components and cables included with the CV-12SLX, see section 2.2.

1.5 TemEBeam Controller (EBC)

In systems without a PLC-based system controller, the TemEBeam Controller (see Figure 1-3) provides the sole means of controlling the e-beam power supply. An EBC is therefore a required accessory for the CV-12SLX in such systems. For detailed information about controlling the CV-12SLX from the EBC, see section 3.5 of this manual. For complete information about installing and operating the EBC see the EBC manual (PN 101-9028-0).

Figure 1-3 EBC Main Control Unit and Hand-Held Controller



2

Installation

2.1 Section Overview

This section describes the procedures required for installation the CV-12SLX power supply. These units have the following top-level PNs:

- 0620-4210-0 (single-gun 208-volt CV-12SLX)
- 0620-4210-1 (single-gun 400-volt CV-12SLX)
- 0620-4210-2 (dual-gun 208-volt CV-12SLX)
- 0620-4210-3 (dual-gun 400-volt CV-12SLX)

The topics covered in this section are:

Section 2.2 List of Components and Cables Supplied with the Unit

Section 2.3 Rack Mounting the Power Module (HVPS)

Section 2.4 Mounting the Filament Power Supply Module(s)

Section 2.5 Grounding Requirements

Section 2.6 Cable Installation

Section 2.6.1 Connecting the Input Power Cables

Section 2.6.2 Connecting the HV Coaxial Cable(s) (PN 0620-8684-1)

Section 2.6.3 Connecting the HV Output Conduit(s) (PN 0620-9654-1)

Section 2.6.4 Connecting the Control/Data Cables

Section 2.6.5 Making I/O Connections to the Vacuum System

CAUTION

Before beginning the installation procedure, make sure that the facility circuit breaker supplying power to the CV-12SLX is switched OFF and locked out with an appropriate lockout/tagout device. Also make sure that the FPS ON/OFF switch and the circuit breaker switch (labeled **AC MAINS**) on the HVPS front panel are both in the OFF position. The facility breaker must remain locked and tagged out during the entire installation procedure. Likewise, the power module's main circuit breaker switch and the FPS ON/OFF switch must both remain in the OFF position during the entire installation procedure. The power-up procedure (see section 3.4) specifies the exact sequence in which power should be applied to the unit.

2.2 List of Components and Cables Supplied with the Unit

2.2.1 Single-gun units

Listed below are the components and cables supplied with single-gun CV-12SLX units.

- One CV-12SLX HVPS, PN 0620-1115-0 (= 208-volt unit) or 0620-1125-0 (= 400-volt unit)
- One filament power supply, PN 0620-6604-0
- One FPS input power cable, PN 6622-0100-20
- One HVPS-FPS cable, PN 0620-6672-0
- One FPS I/O cable, PN 0620-6672-2
- One HVPS I/O cable, PN 0620-6682-2
- One HV coaxial cable, PN 0620-8684-1
- One HV cable/conduit assembly, PN 0620-9654-1
- One bracket (PN 0040-9982-0) for securing HV conduit to HV feedthroughs source tray
- One 16" grounding hook, PN 9900-4864-0
- One 20' coil of 3"-wide copper strap, PN 5621-0032-3
- One coil of 1/2"-wide copper strap, PN 5621-0032-0
- One connector for connecting a user-supplied AC input power cable to the HVPS
- One copy of the CV-12SLX Technical manual

2.2.2 Dual-gun units

Listed below are the components and cables supplied with dual-gun CV-12SLX units.

- One CV-12SLX HVPS, PN 0620-1115-1 (= 208-volt unit) or 0620-1125-1 (= 400-volt unit)
- Two filament power supply modules, PN 0620-6604-1
- Two FPS input power cables, PN 6622-0100-20
- Two HVPS-FPS cables, PN 0620-6672-0
- One FPS I/O cable, PN 0620-6672-2
- One HVPS I/O cable, PN 0620-6682-2
- Two HV coaxial cables, PN 0620-8684-1
- Two HV cable/conduit assemblies, PN 0620-9654-1
- Two brackets (PN 0040-9982-0) for securing HV conduits to HV feedthroughs on source tray
- One 16" grounding hook, PN 9900-4864-0
- One 20' coil of 3"-wide copper strap, PN 5621-0032-3
- One coil of 1/2"-wide copper strap, PN 5621-0032-0
- One connector for connecting a user-supplied AC input power cable to the HVPS
- One copy of the CV-12SLX Technical manual

2.3 Rack Mounting the Power Module (HVPS)

2.3.1 General Installation Guidelines

The CV-12SLX HVPS can be rack mounted in a standard 19" rack cabinet. It must be supported by two side shelf supports to hold the power supply weight. The rack vertical height required is 8-3/4 inches. The chassis depth is 23 inches. An additional 3" is required for clearance of terminals, plugs, and wiring. The panel should be secured to the rack cabinet by the four mounting holes provided.

DANGER: HIGH VOLTAGE

Removal of the HVPS top cover can expose personnel to dangerous or lethal voltages. Particular care should be taken regarding high voltage, which can arc over a considerable distance. It is not necessary to be in physical contact with a live terminal in order for an arc to send a lethal high-voltage discharge through a person's body.

The HVPS is designed to be installed in an indoor laboratory or clean room in which the immediate environment is controlled to maintain an ambient temperature of 40° C or lower and a noncondensing humidity level of 10%-90%. Together, the screen covering the front panel air vent plus the screen sandwiched between the exhaust fan and the rear panel provides IP40 ingress protection. These screens prevent solid foreign objects larger than 1 mm in diameter from penetrating the outside chassis but do not provide a barrier against liquids. Both screens must be removed and cleaned whenever the fan airflow drops more than 15% from its original value or every two years, whichever comes first. The power module does not require any routine maintenance, aside from the cleaning of the screens.

2.3.2 Air Flow Requirements

The inverters have a temperature sensor that will shut down and latch out further operation if an overtemperature condition should occur. The customer must ensure a free flow of air is maintained through the cabinet and keep the ambient air temperature at the input to the power supply below 104° F (40° C). All air passages must be unobstructed. If air filters are used on the cabinet air input, they should be checked on a regular schedule for dirt and dust accumulation.

CAUTION

Cabinet doors and panels must not block air vents located on the unit's front and rear panels, providing at least 2" of clearance from these vents. A fan located on the rear panel pulls air in through the vents on the front panel, and exhausts warmer air through the rear vent.

2.4 Mounting the Filament Power Supply Module(s)

Install the FPS module(s) in the vacuum cubicle, within 6 feet of the high-voltage feedthroughs that supply power to the e-beam gun. To do so, first drill four holes at the installation location, in the pattern shown in Figure 2-1. Then place the holes in the bottom of the FPS module over the drilled holes and secure the FPS in place with the hardware provided.

DANGER: HIGH VOLTAGE

Removal of any of the covers on the FPS module can expose personnel to dangerous or lethal voltages. Particular care should be taken regarding high voltage, which can arc over a considerable distance. It is not necessary to be in physical contact with a live terminal in order for an arc to send a lethal high-voltage discharge through a person's body.

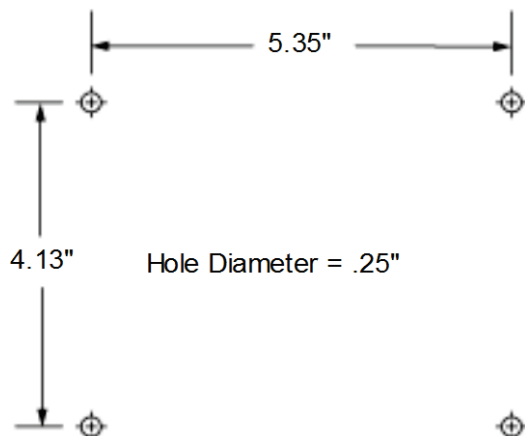
Figure 2-1 Mounting Hole Pattern for FPS Module(s)

2.5 Grounding Requirements

2.5.1 Facility Low-Impedance Grounding Requirements

Safe, dependable operation of the power supply cannot be ensured unless a good earth ground is provided for the system and the power supply. This ground must provide a low-impedance path for radio frequency (RF) as well as direct current (dc) electricity, and it must not be connected to that of any other system or equipment. Figure 2-2 shows two different methods of providing the required low-impedance ground on the facility side of the installation.

2.5.2 System Low-Impedance Grounding

Within the vacuum system, the low-impedance ground is provided by 3"-wide and 1/2"-wide copper straps. As Figure 2-3 shows, these straps must connect:

- the grounding stud labeled **RF GND** on the power module's rear panel (see Figure 2-4) to a grounding point on the frame of the operator station
- the operator station's grounding point to the vacuum cubicle's central grounding point
- the grounding stud labeled **RF GND** on the FPS front panel (see Figure 2-) to the vacuum cubicle's main grounding point
- the source tray to the vacuum cubicle's main grounding point.

Figure 2-3 shows the low-impedance ground connections for a single-gun system. Low-impedance ground connections are identical on two-gun units, except that an additional length of 1/2"-wide copper strap must connect the system's central grounding point to FPS #2. For an additional diagram relating to low-impedance grounding, see either document 0101-8300-0, the Quick Start Guide for single-gun CV-12SLX units, or document 0101-8300-1, the Quick Start Guide for dual-gun units.

Figure 2-3 System Low Impedance Grounding Requirements

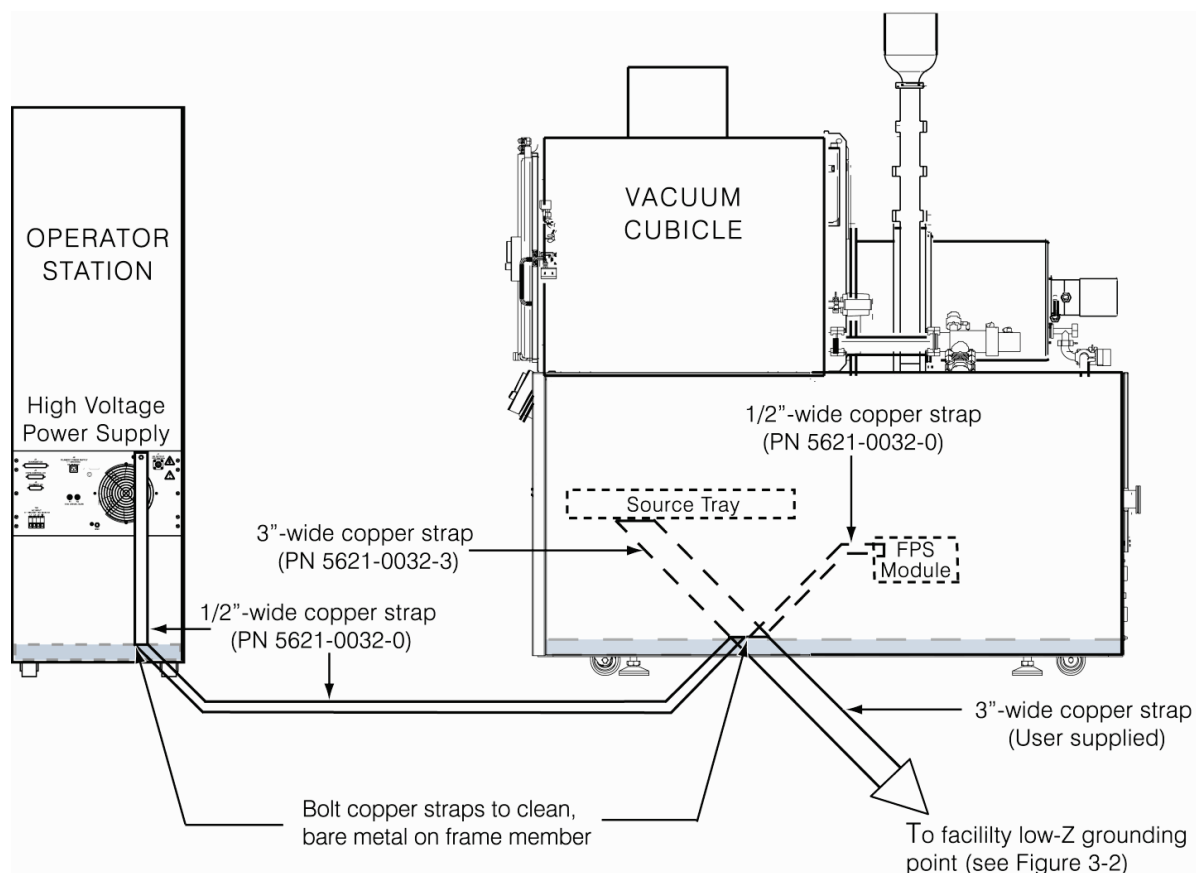

2.5.3 Power Module Grounding

Make connections to the power supply's grounding lugs as shown in the Quick Start Guides for the CV-12SLX, following the procedure described below.

- | Step | Action |
|------|---|
| 1 | A roll of 1/2"-wide copper strap (PN 5621-0032-0) is supplied with the unit. Cut off a length of this strap that will easily extend from the grounding lugs on the power module's rear panel to the operator station's frame. |
| 2 | Secure one end of this strap to the grounding stud labeled RF GND on the power module's rear panel (see Figure 2-4). |

Figure 2-4 Rear Panel of Single Gun CV-12SLX HVPS

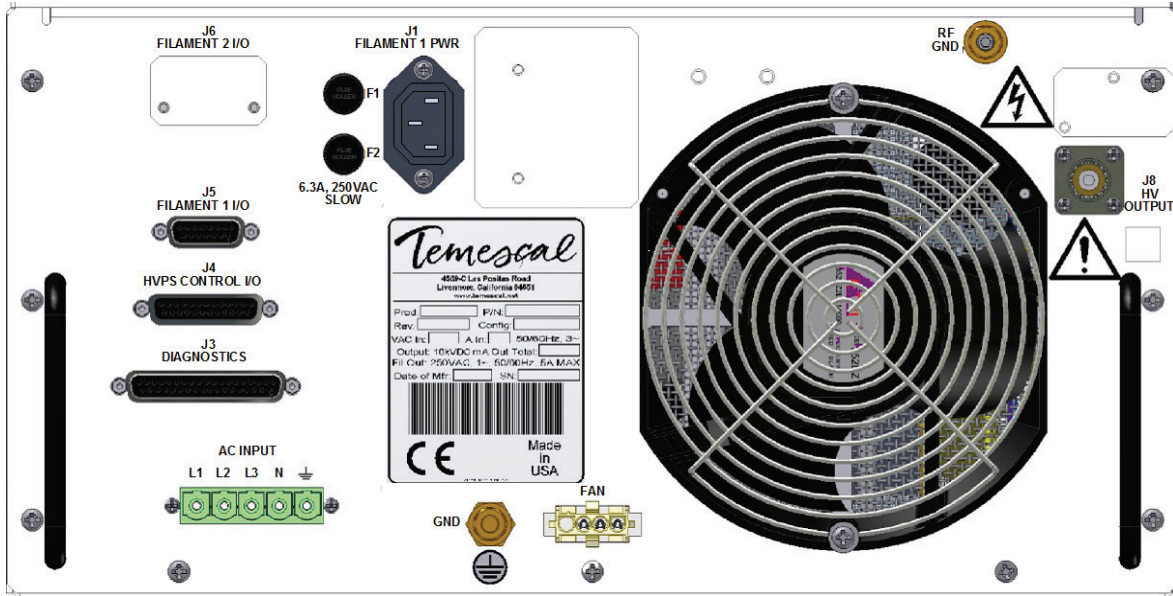
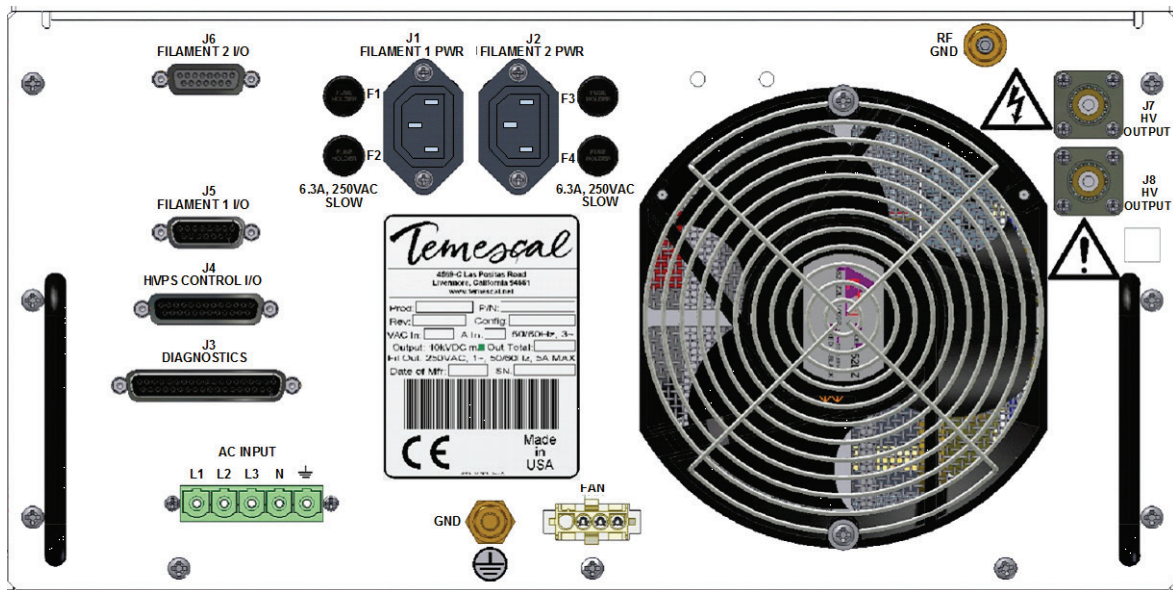

Figure 2-5 Rear Panel of Dual Gun CV-12SLX HVPS



- 3 Secure a length of #10 AWG wire to the grounding lug labeled GND on the power module rear panel.
- 4 Secure the loose end of the 1/2" copper strip and the loose end of the #10 AWG ground wire to a clear, bare patch of metal on the operator station's frame. The same fastener that secures the above copper strip to the frame should also secure one end of a length of 3" copper strap that connects to the vacuum cubicle's central grounding point, as shown in Figure 2-3.

2.5.4 Filament Power Supply Grounding

Make connections to the grounding lugs on the FPS front panel as shown in one of the Quick Start Guides for the CV-12SLX, following the procedure described below.

- | Step | Action |
|------|--|
| 1 | Cut a length of 1/2"-wide copper strap (user-supplied) that will easily extend from the filament power supply to the vacuum cubicle's central grounding point. |
| 2 | Secure one end of this strap to the grounding stud labeled RF GND on the FPS front panel (see Figure 2-). |

Figure 2-6 Grounding Studs on FPS Front Panel

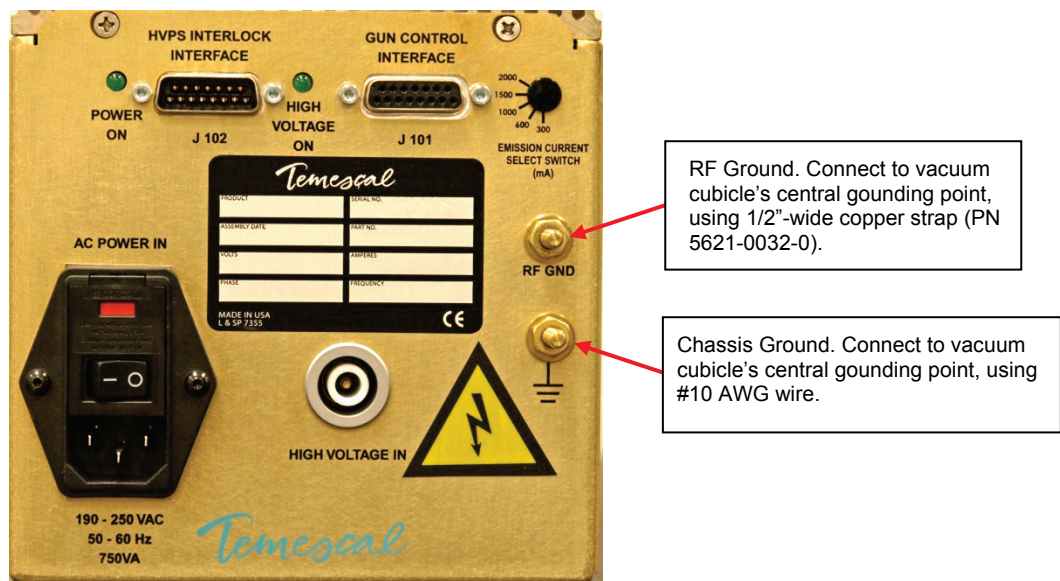

- 3 Secure a length of #10 AWG wire to the other grounding lug on the FPS front panel.
- 4 Secure the free ends of the 1/2" copper strip and the #10 AWG ground wire to the vacuum cubicle's central grounding point.

2.5.5 Electron Beam Source Ground

To ensure a good ground between the electron beam source and the vacuum cubicle, the following conditions must be met:

- The base of the source and the surface on which it is mounted (usually the upper surface of the source tray) must be clean and free of evaporated material.
- The mounting surface must be made of nonmagnetic material.
- The source must be securely bolted to the mounting surface.

2.5.6 Mounting the Grounding Hook

If you are installing the CV-SLX unit in a system that does not already have a properly mounted grounding hook, install the grounding hook provided with the power supply in the vacuum cubicle, attaching its pigtail to the vacuum cubicle's central grounding point and the grounding hook's storage bracket at a convenient location nearby.

2.6 Cable Installation

For an illustration of single-gun cabling details, see Quick Start Guide PN 0101-8300-0. For a diagram of dual-gun cabling details, see Quick Start Guide PN 0101-8300-1. For detailed instructions on connecting the cables shown in this diagram, see sections 2.6.1 through 2.6.5.

2.6.1 Connecting the Input Power Cables

Connecting the Power Module Input Power Cable

CAUTION

Make sure that the main power breaker on the HVPS front panel is in the OFF position and remains in that position throughout the installation procedure.

On 208-V CV-12SLX units, the input power wiring must meet the following specifications:

- 50 A, 3-Phase delta, 4-conductors, each #6 AWG stranded UL1015 wire (Also consult local electrical codes.)

Wire the conductors in this cable into the input power terminal connector supplied with the HVPS (see Figure 2-), so that the three hot wires will connect to rear panel receptacles **L1**, **L2**, and **L3** and the ground wire will connect to the receptacle marked as a ground (see Figure 2-4). Then plug the terminal connector into the rear panel INPUT POWER receptacle.

Figure 2-7 Input Power Connections to 208-Volt HVPS Units

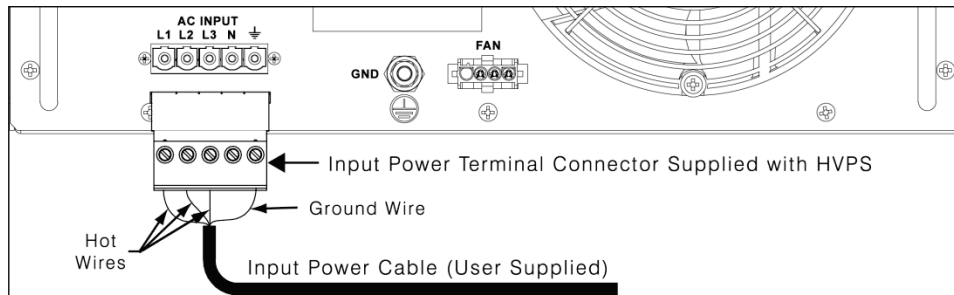

On 400-V units, input power wiring must meet the following specifications:

- 30 A, 2-Phase wye, 5-conductors (including neutral), each #10 AWG stranded UL1015 wire (Also consult local electrical codes.)

Wire the conductors in this cable into the input power terminal connector supplied with the HVPS (see Figure 2-), so that the three hot wires will connect to rear panel receptacles **L1**, **L2**, and **L3**, the neutral wire will connect to rear panel receptacle **N**, and the ground wire will connect to the receptacle marked as a ground. Then plug the terminal connector into the rear panel INPUT POWER receptacle.

Figure 2-8 Input Power Connections to 400-Volt HVPS Units

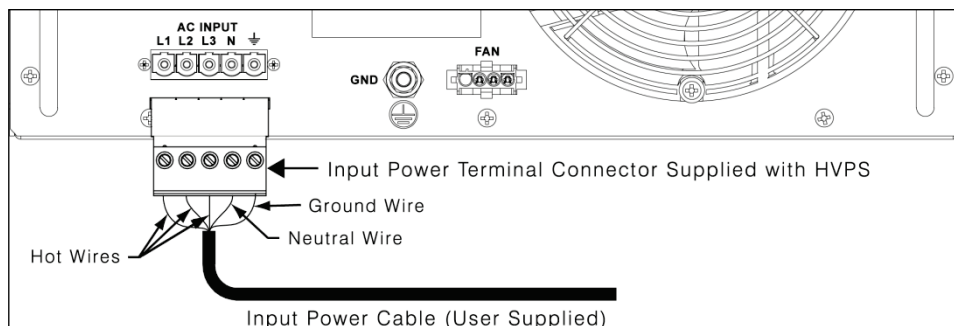

Connecting the FPS Input Power Cable(s) (PN 6622-0100-20)

An FPS power cable (PN 6622-0100-20) is provided for each FPS. In one-gun installations, plug one end of this cable into HVPS rear panel connector J1 (see Figure 2-4). In two-gun installations, plug the power cable for FPS #1 into J1 and the power cable for FPS #2 into J2. Plug the other end of the power cable into the power receptacle on the FPS front panel (see Figure 2-5).

CAUTION

Make sure that the ON/OFF switch on the FPS front panel (see Figure 2-) remains in the OFF position throughout the installation procedure.

Figure 2-9 Input Power and HV Connections on FPS Front Panel

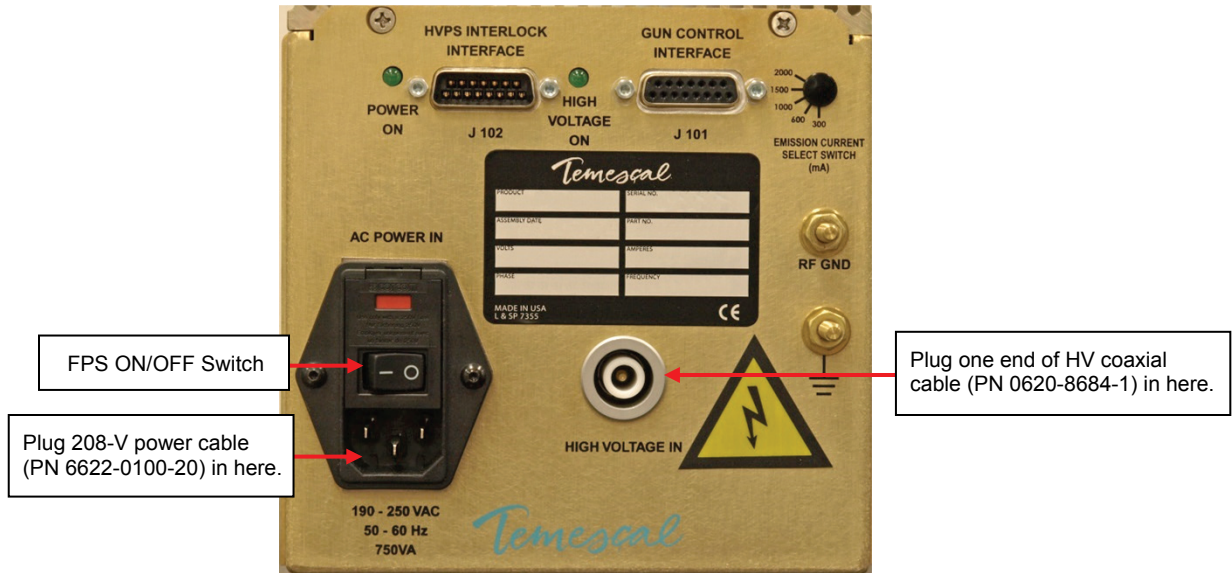

2.6.2 Connecting the HV Coaxial Cable(s) (PN 0620-8684-1)

The HV coaxial cable (PN 0620-8684-1) conducts the high voltage output of the power module to the FPS module(s). In one-gun installations, plug one end of this HV cable into HVPS rear panel connector J7 (see Figure 2-4). In two-gun installations, plug the HV cable for FPS #1 into J7 and the HV cable for FPS #2 into J8 (see Figure 2-5). Connect the other end of each HV cable to the HIGH VOLTAGE IN connector on the FPS front panel (see Figure 2-).

2.6.3 Connecting the HV Output Conduit(s) (PN 0620-9654-1)

The cables that conduct the high voltage from the FPS to the source tray are contained in a length of flexible conduit. The part number of the HV cable/conduit assembly is 0620-9654-1. The instructions below describe how to install the HV conduit in a single-gun installation. In a dual-gun installation, the only additional step is determining which gun will be designated as gun #1. The HV conduit for that gun should be connected to the FPS module that has been designated as FPS #1.

Connecting the HV Output Cables and Conduit to the FPS

Connect the HV cable/conduit assembly to the FPS rear panel (see Figure 2-), following the procedure described below.

Step	Action
1	Remove four screws that secure the conduit panel to the FPS rear panel, as shown below.

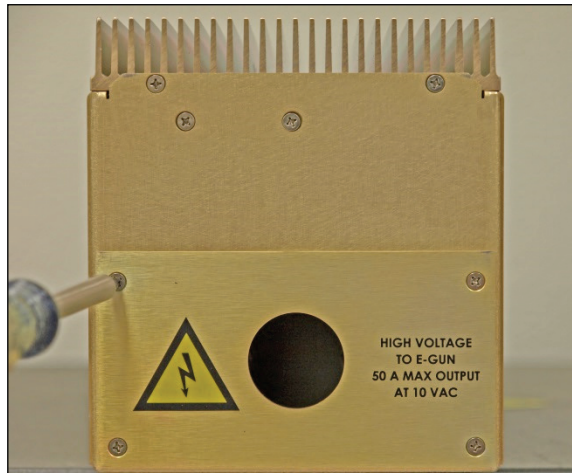
Figure 2-10 Removing the FPS Conduit Panel

- 2 Insert the threaded end of the conduit elbow into the hole in the conduit panel and secure the elbow with the nut provided, as shown in Figure 2-.

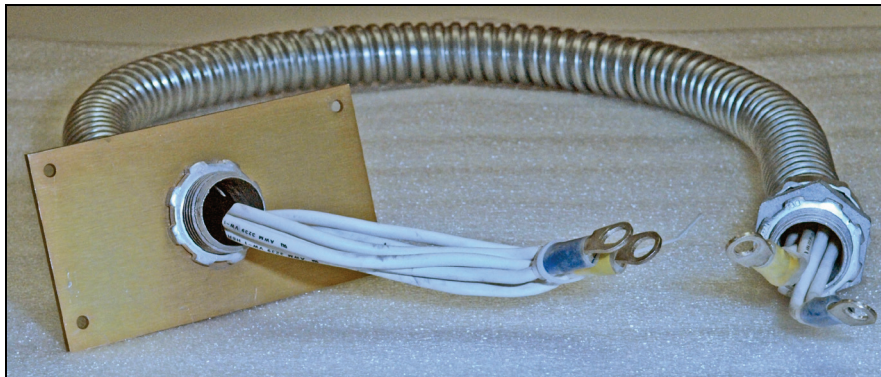
Figure 2-11 Conduit Properly Secured to FPS Conduit Panel

- 3 Figure 2- shows the FPS with its conduit panel removed and with the lugs on the ends of the HV cables properly secured to the studs inside the FPS unit.

Figure 2-12 HV Output Cables Secured to Studs inside FPS

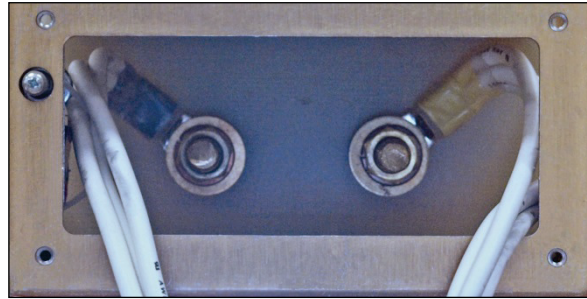

- 4 Replace the conduit panel, taking care to secure it in place with all four screws.

Connecting the HV Output Cables and Conduit at the Source Tray

Connect the other end of the HV output cables to the HV feedthroughs in the source tray, following the instructions provided below.

CAUTION

If you are installing a two-gun unit, make sure that the HV conduit/cable connected to FPS #1 gets connected to the source designated as Source #1 and likewise for FPS #2 and Source #2.

CAUTION

If the vacuum system has previously been in use with a high-voltage power supply, then before performing this procedure, touch the source tray and the terminals on both HV feedthroughs with a properly connected grounding hook.

Step	Action
1	Remove the nut that secures one of the feedthroughs to the underside of the source tray.
2	Install the HV conduit bracket (PN 0040-9982-0) supplied with the unit and secure it with the nut removed in Step 1, as shown in Figure 2-13.

Figure 2-13 HV Conduit Bracket Properly Installed on HV Feedthrough



- 3 Using the nut supplied with the conduit, secure the conduit to the bracket as shown in Figure 2-14.

Figure 2-14 HV Conduit Properly Secured to Bracket



- 4 Secure the lugs on the ends of the HV cables to the feedthroughs, as shown in Figure 2-13. Either cable can be connected to either feedthrough, as polarity is not an issue.

2.6.4 Connecting the Control/Data Cables

Step	Action
1	Plug the male end of the HVPS-FPS cable (PN 0620-6672-0) into connector J5 on the power module rear panel (see Figure 2-4).
2	Plug the female end of the HVPS-FPS cable for Gun #1 into connector J102 on the front panel of FPS #1 (see Figure 2-15).

Figure 2-15 Control/Data Cable Connections on FPS Front Panel

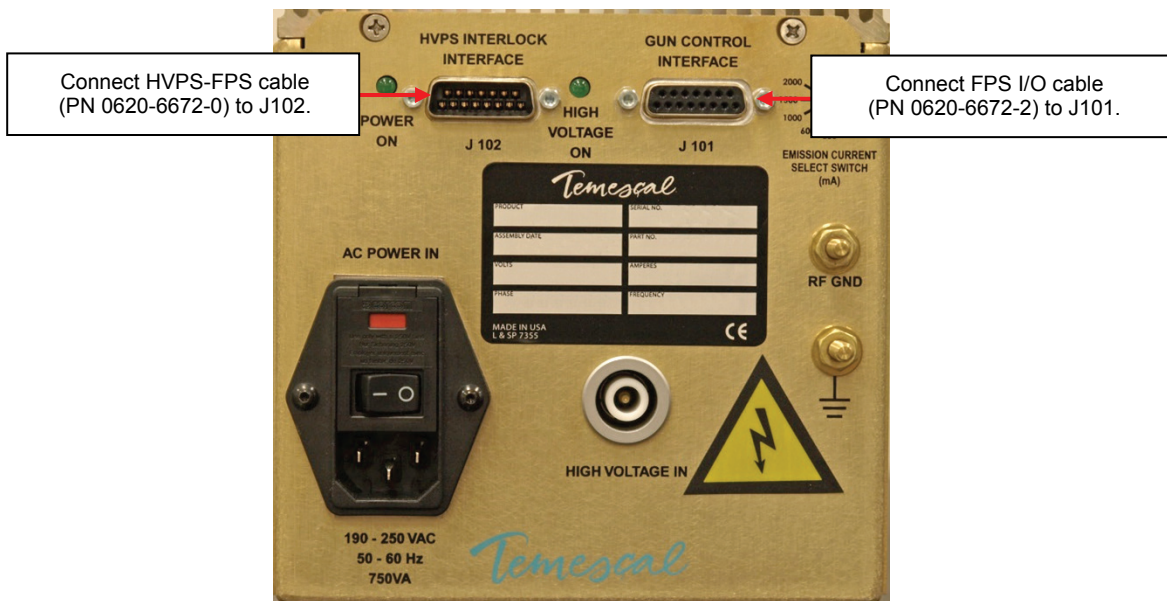

- 3 Plug the male end of the same HVPS I/O cable (PN 0620-6682-0) into HVPS rear panel connector J4 (see Figure 2-4).
- 4 Plug the male end of the FPS I/O cable (PN 0620-6672-2) for Gun #1 into connector J101 on the front panel of FPS #1 (see Figure 2-15). If this is a single-gun installation, skip Steps 5-7 and proceed to Step 8 of this procedure. If you are performing a dual-gun installation, you must also complete Steps 5-8 below.
- 5 Plug the male end of the HVPS-FPS cable (PN 0620-6672-0) for Gun #2 into connector J6 on the HVPS rear panel (see Figure 2-5).
- 6 Plug the female end of the same HVPS-FPS cable into connector J102 on the front panel of FPS #2 (see Figure 2-15).
- 7 Plug the male connector on one end of the FPS I/O cable (PN 0620-6672-2) for Gun #2 into front panel connector J101 on FPS #2 (see Figure 2-15).
- 8 Make the I/O connections to the control system, as described in section 2.6.5.

2.6.5 Making I/O Connections to the Vacuum System

NOTE

Before performing this portion of the installation procedure, perform the mandatory baseline test described in Section III of either document 0101-8300-0, the Quick Start Guide for single-gun CV-12SLX units, or document 0101-8300-1, the Quick Start Guide for dual-gun CV-12SLX units.

The installer must make connections (1) between the vacuum system and the HVPS I/O cable (PN 0620-6682-0) and (2) between the vacuum system and the FPS I/O cable (PN 0620-6672-2). Control inputs and status outputs include both digital and analog signals. Digital inputs require a simple contact closure and carry 24 V dc at approximately 20 mA. All digital outputs are +24 V dc sourcing a maximum of 50 mA. For detailed information about the I/Os exchanged via the HVPS I/O cable, see Figure 2-16 and Table 2-1. For details about I/Os exchanged via the FPS I/O cable, see Figure 2-17 and Table 2-2.

When making I/O connections to the HVPS I/O cable, use either the optional 25-pin interface module available from Temescal (PN 6149-2293-637) or a comparable interface module. When making I/O connections to the FPS I/O cable, use either the optional 15-pin interface module available from Temescal (PN 6149-2293-624) or a comparable interface module.

Figure 2-16 System I/Os Exchanged via HVPS Rear Panel Connector J4 and the HVPS I/O Cable (PN 0620-6682-0)

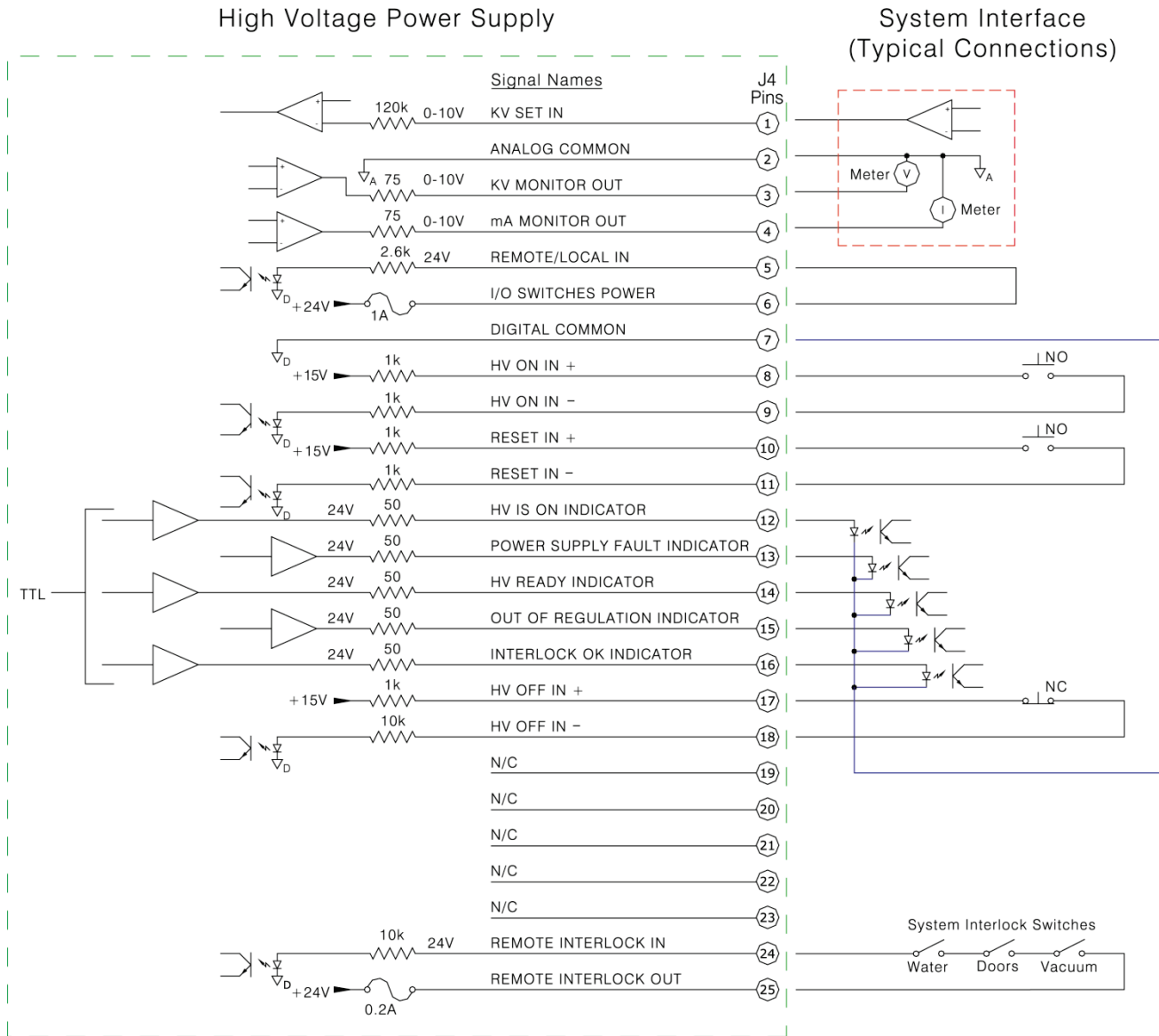

NOTE

Because the interlock string is internally supplied with 24 V dc, only contact closure must be supplied by the vacuum system. Care must be taken not to allow voltages from other sources to affect the external interlock loop, as safety could thereby be compromised. In addition, the application of additional voltage sources to the interlock circuit will damage it.

Table 2-1 Descriptions of I/Os Exchanged via HVPS Rear Panel Connector J4 and the HVPS I/O Cable (PN 0620-6682-0)

Signal Name	Pin	I/O Type	Description
KV SET IN	1	Analog input	HV adjustment input, 0-10 V dc = 0-10 KV. Controls high voltage if Pin 5 is high, in which case the HVPS front panel OUTPUT KV ADJUST pot is disabled.
ANALOG COMMON	2	Analog common	Common for KV MONITOR OUT and mA MONITOR OUT outputs (see Pins 3 and 4), if used. Connect to vacuum system ground.
KV MONITOR OUT	3	Analog output	High voltage monitor output, linear (0-10 V dc = 0-10 kV).
mA MONITOR OUT	4	Analog output	Emission current monitor output., linear. Scaling is factory set (0-10 V dc = 0-1500 mA).
REMOTE/LOCAL IN	5	Digital input	Selects either remote or local HV control. If high, (i.e., if +24 V dc is supplied), then 0-10 dc input via Pin 1 controls HV exclusively. If low, then HVPS front panel OUTPUT KV ADJUST pot exclusively controls the high voltage.
I/O SWITCHES POWER	6	DC voltage	+ 24 V dc output, fused at 1 A. Can be used to supply Pin 5, if remote HV control via Pin 1 is desired. NOTE: To be used only for power supply control; do NOT use this voltage to drive any external device.
DIGITAL COMMON	7	Digital common	Common for digital indicator signals output via Pins 12, 13, 14, 15, and 16, if any of them are used.
HV ON IN +	8	Digital input	Controlled by a normally open external switch. If HV OFF IN + is high, then a momentary contact closure between Pins 8 and 9 switches the high voltage ON.
HV ON IN –	9	DC voltage	+ 15 dc output supplied to Pin 8 via a normally open switch.
RESET +	10	Digital input	Controlled by a normally open external switch. If the POWER SUPPLY FAULT INDICATOR output (Pin 13) is true, then a momentary contact closure between Pins 10 and 11 resets the HVPS.
RESET –	11	DC voltage	+ 24 dc output supplied Pin 10 via a normally open switch controlling.
HV IS ON INDICATOR	12	Digital output	When high (+24 V dc), this output indicates that the high voltage is ON.
POWER SUPPLY FAULT INDICATOR	13	Digital output	When high, this output indicates that a latching power supply fault has occurred. For additional details about latching PS faults, see section 5.2.
HV READY INDICATOR	14	Digital output	When high, this output indicates that the HV can be switched on. This indicator is high when the HV OFF IN+ input supplied via Pin 17 is high.
OUT OF REGULATION INDICATOR	15	Digital output	High whenever the HVPS front panel HV OUT OF REGULATION LED is lit. For additional details about that LED, see section 5.2.
INTERLOCK OK INDICATOR	16	Digital output	High when all interlocks are made, so that the REMOTE INTERLOCK IN input (Pin 24) is high.
HV OFF IN+	17	Digital input	Controlled by a normally closed external switch. This input is high when the HV is OFF and when no latching power supply faults exist. When the HV is ON, then momentary opening of the external contact closure between Pins 17 and 18 switches off the HV.
HV OFF IN–	18	DC voltage	+ 15 dc output supplied to Pin 17 via a normally closed switch.
REMOTE INTERLOCKS IN	24	Digital input	High when the external interlock string is made; connect to Pin 24 via external interlock switches.
REMOTE INTERLOCKS OUT	25	DC voltage	+ 24 dc output, fused at 0.2 A and supplied to Pin 24 via external interlock switches. NOTE: Minimum external interlocks required are WATER (= e-beam gun's water-flow switch is true), DOORS (= all vacuum cubicle doors are closed), and VACUUM (= vacuum system is pumped down to crossover point). If e-beam position is controlled by a beam sweep controller, a POSITION interlock signal from that component must also be true. NOTE: Within the HVPS, the external interlock string is connected in series with the internal interlocks for the HVPS and FPS covers.

Figure 2-17 System I/Os Exchanged via FPS Front Panel Connector J101 and the FPS I/O Cable (PN 0620-6672-2)

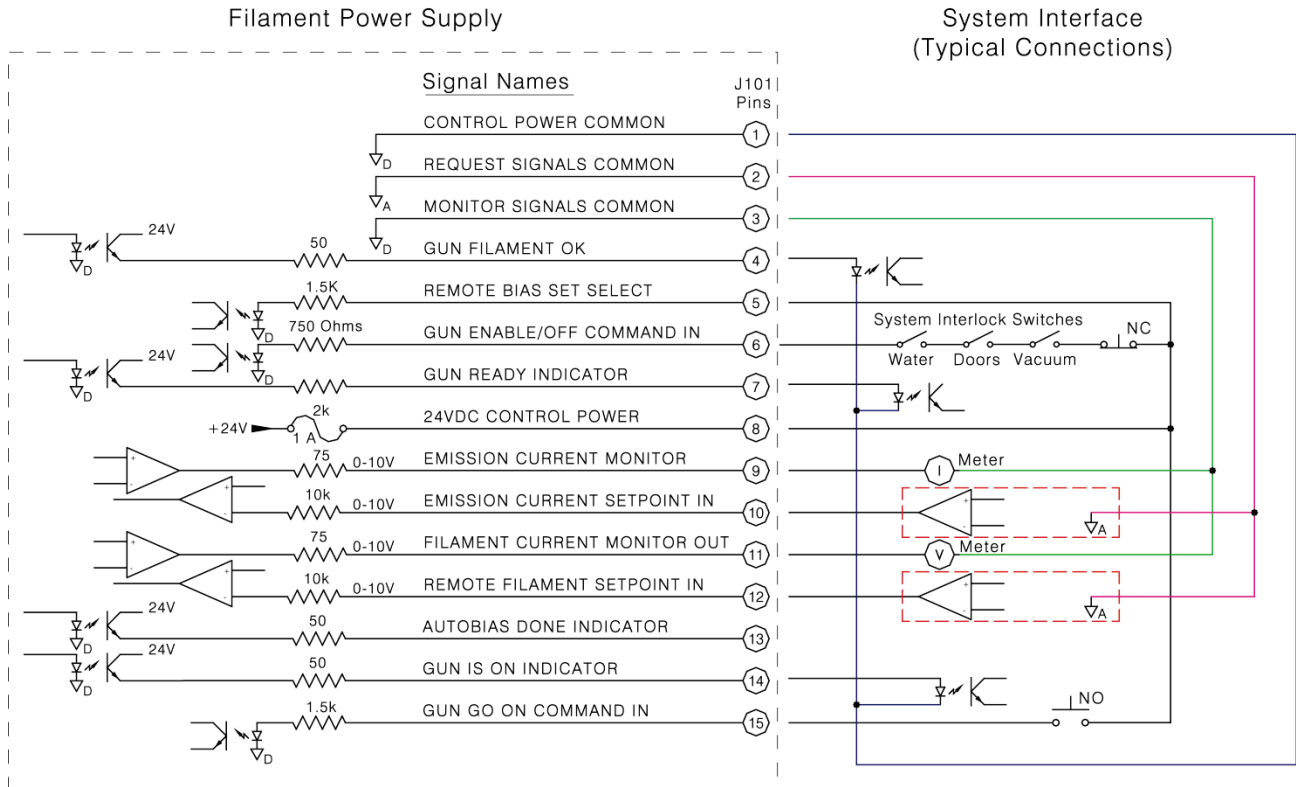

NOTE: DEPOSITION CONTROLLER INPUT
 On the CV-12SLX power supply, the polarity of the emission current request input (J101 Pin 10) must be positive. Reversal of this input's polarity may result in damage to the power supply.

Table 2-2 Descriptions of I/Os Exchanged via FPS Rear Panel Connector J101 and the FPS I/O Cable (PN 0620-6672-2)

Signal Name	Pin	I/O Type	Description
CONTROL POWER COMMON	1	Common for digital outputs	+24 V dc return for the following digital outputs: GUN FILAMENT OK (Pin 4), GUN READY INDICATOR (Pin 7), and GUN IS ON INDICATOR (Pin 14).
REQUEST SIGNALS COMMON	2	Common for analog inputs	Common for the following analog request inputs: REMOTE EMISSION I SETPOINT IN (Pin 10) and REMOTE FILAMENT I SETPOINT IN (Pin 12).
MONITOR SIGNALS COMMON	3	Common for analog outputs	Common for the following analog outputs: EMISSION I MONITOR OUT (Pin 9) and FILAMENT I MONITOR OUT (Pin 11).
GUN FILAMENT OK	4	Digital output	When high (+ 24 V dc), this output indicates that the gun's filament current is flowing (i.e., that the filament is not broken and that the electrical path to it from the FPS is not shorted to ground).
REMOTE BIAS SET SELECT	5	Digital input	If this input is high, then the bias current setpoint is determined by the REMOTE FILAMENT I SETPOINT IN input supplied via Pin 12, and the FPS's internal Autobias circuit is disabled. The default is to set this input high by connecting it to Pin 8. To determine whether the internal autobias circuit will produce better results for your application, consult Temescal.
GUN ENABLE/OFF COMMAND IN	6	Digital input	Connect to Pin 8 via a normally closed external switch. When this input is high, then the gun (i.e., filament current) is OFF, and the GUN READY INDICATOR signal goes true. When the gun is ON, momentary loss of the GUN ENABLE/OFF COMMAND IN contact closure switches the gun OFF. For maximum equipment protection, wire an additional set of system interlock switches in series with those wired into the REMOTE INTERLOCKS loop for the high voltage (see Pins 24 and 25 in Figure 2-16). NOTE: The minimum safety requirement is a DOORS interlock switch installed before the normally closed switch required between J101 Pins 6 and 8.
GUN READY INDICATOR	7	Digital output	This output goes high (+24 V dc) when the GUN ENABLE/OFF COMMAND IN signal is high.
24VDC CONTROL POWER	8	DC voltage	+ 24 dc output supplied for the following inputs: REMOTE BIAS SELECT (Pin 5), GUN ENABLE/OFF COMMAND IN (Pin 6), and GUN GO ON COMMAND IN (Pin 15). NOTE: To be used only for power supply control; do NOT use this voltage to drive any external device.
EMISSION I MONITOR	9	Analog output	0-10 V dc output, linear. Scaling of this output depends on position of the EMISSION CURRENT SELECT switch on the FPS front panel (see Figure 4-2), which is factory set to 1500 mA for the CV-12SLX. Therefore, scaling of the EMISSION CURRENT I MONITOR output is 0-10 V dc = 0-1500 mA.
REMOTE EMISSION I SETPOINT IN	10	Analog input	0-10 V dc input, linear. Scaling of this input depends on the position of the EMISSION CURRENT SELECT switch on the FPS front panel, which is factory set to 1500 mA. Therefore, scaling of the REMOTE EMISSION I SETPOINT IN input is 0-10 V dc = 0-1500 mA.
REMOTE FILAMENT I MONITOR OUT	11	Analog output	0-10 V dc output, linear. Scaling of this output is 0-10 V dc = 0-100 A for -0 and -1 FPS units. For FPS units whose PN ends in -2, scaling is 0-10 V dc = 0-50 A.
REMOTE FILAMENT I SETPOINT IN	12	Analog input	0-10 V dc input, linear. Connect to Pin 2. If the REMOTE BIAS SET SELECT input (Pin 5) is high, then this input controls the filament current's bias setting. Scaling is 0-10 V dc = 0-100 A for -0 and -1 FPS units. For FPS units whose PN ends in -2, scaling is 0-10 V dc = 0-50 A.
AUTOBIAS DONE INDICATOR	13	Digital output	If the REMOTE BIAS SET SELECT input (Pin 5) is low, then the FPS autobias circuit controls the bias current setpoint. In that case, the AUTOBIAS DONE INDICATOR goes high after the FPS autobias sequence is completed.
GUN IS ON INDICATOR	14	Digital output	When high, this output indicates that the gun is ON.
GUN GO ON COMMAND IN	15	Digital input	Connect to Pin 8 via a normally open contact closure. If the GUN ENABLE/OFF COMMAND IN signal (Pin 6) is high, then momentary closure of this contact switches the gun ON.

3 Power Supply Operation

3.1 Section Overview

This section covers the following topics:

Section 3.2 HVPS Front Panel Controls and Indicators

Section 3.3 Switches and LEDs on the FPS Front Panel

Section 3.4 Power-Up Procedure

Section 3.5 Control of Power Supply from a TemEBeam Controller (EBC)

Section 3.6 Control of Power Supply by a PLC-Based System Controller

Section 3.7 Responding to Latching Power Supply Faults

3.2 HVPS Front Panel Controls and Indicators

Figure 3-1 shows the controls and indicators on the front panel of the CV-12SLX HVPS. Those features are described in detail below.

Figure 3-1 CV-12SLX HVPS Front Panel

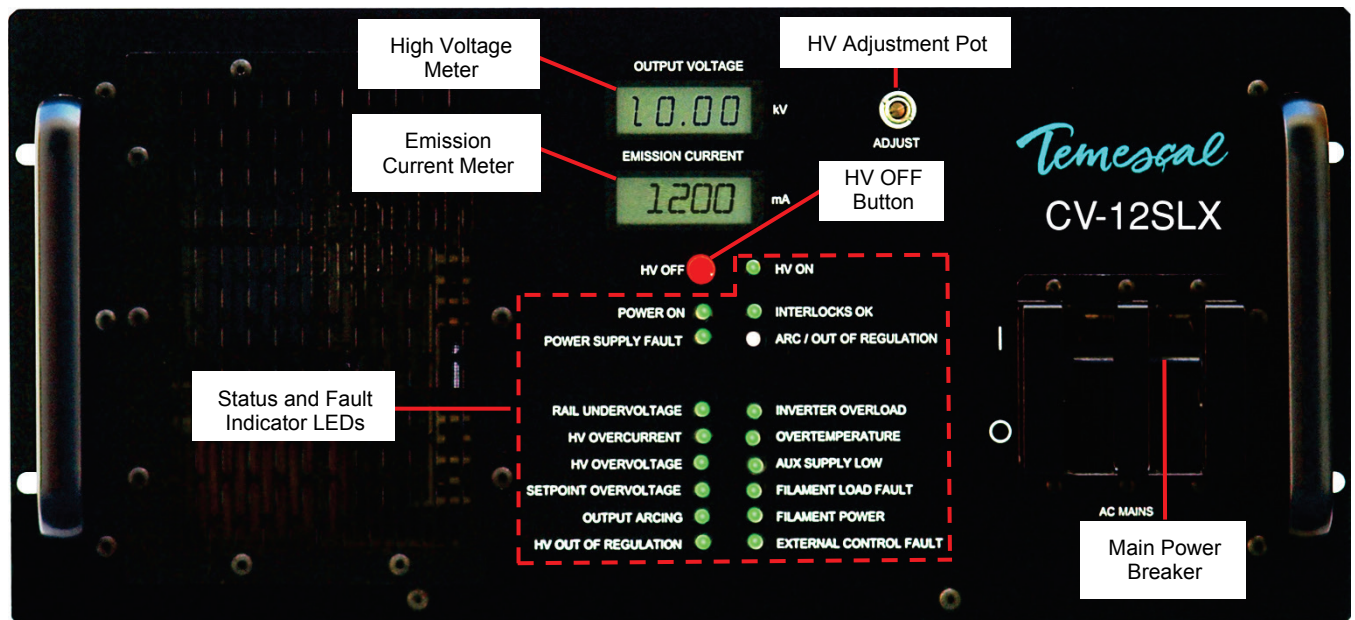

3.2.1 HVPS Front Panel Controls

Main Circuit Breaker Switch (Labeled **AC MAINS**)

High-Voltage Adjustment Pot (labeled **ADJUST**)

HV OFF Button. This button is always active when the HVPS is powered up. Note that pushing it when the HV is on switches it off, and pushing it when the HV is off due to a latched fault condition resets the power supply.

3.2.2 HVPS Front Panel Indicators

Display Meters

- **Output Voltage** meter (0–10 kV)
- **Emission Current** meter (0–600 mA)

Status LEDs

- **Power ON** LED. Turns green to indicate that the HVPS is powered up.
- **HV ON** LED. Lights yellow when HVPS is powered up but HV is OFF. Turns green when the HV is switched on.

Fault Indicator LEDs

For detailed information about fault indicator LEDs, see sections 5.2.2 and 5.2.3.

3.3 Switches and LEDs on the FPS Front Panel

Figure 3-2 shows the switches and LEDs on the FPS front panel.

Figure 3-2 Filament Power Supply Front Panel

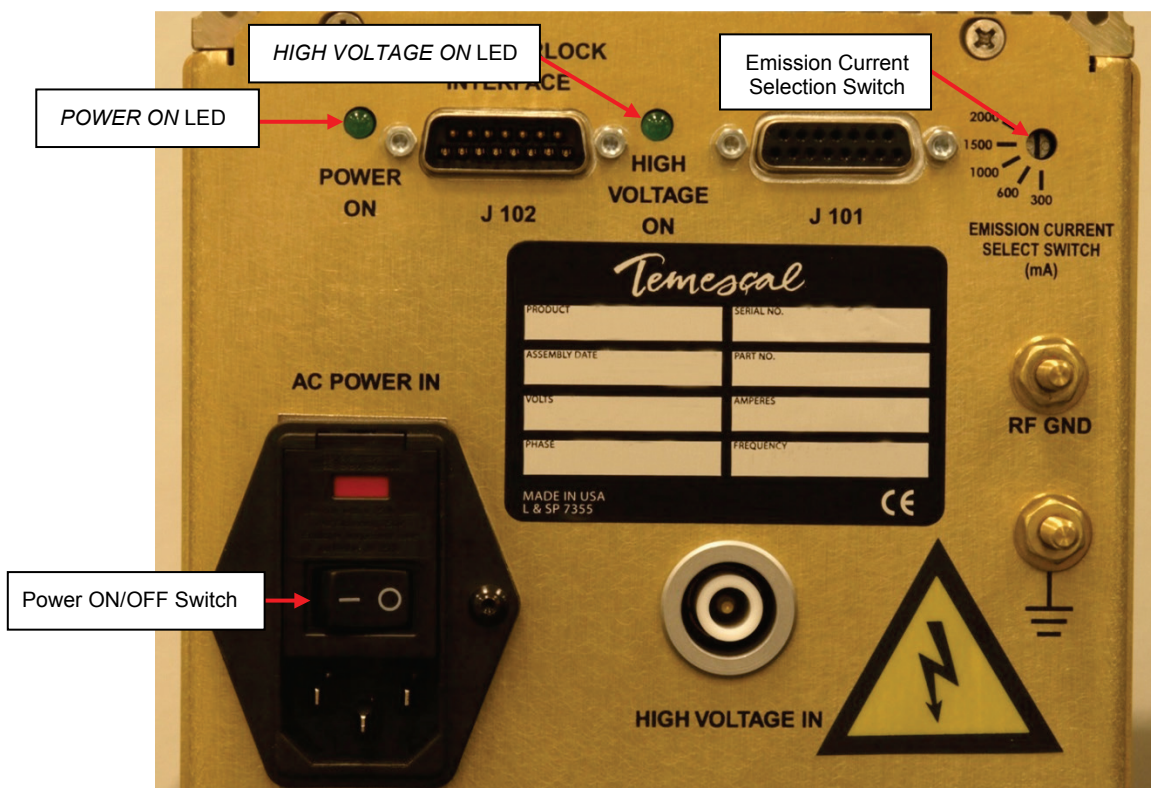

The switches and indicators on the FPS front panel are:

- Power ON/Off switch: Must be switched ON in order for unit to operate.
- **POWER ON** LED: When lit, indicates that the HVPS and the FPS are both powered up.

- **HIGH VOLTAGE ON LED:** Lights when the HV IS ON signal from the HVPS is high.
- **EMISSION CURRENT SELECTION SWITCH:** Position of this switch determines scaling of remote emission current request inputs and monitoring outputs. A black plastic cap normally covers this switch, which is factory set and should require no further attention. Figure 3-2 shows the switch set to the 300-mA position. However, for the CV-12SLX, its default setting is **1500**, which means that scaling of the emission current request input and monitoring outputs is 0-10 V dc = 0-1500 mA.

3.4 Power-Up Procedure

Follow the procedure described below when powering up the unit when it has been powered down and lock/tagged out at the facility breaker (e.g., for maintenance).

Step	Action
1	If you are powering up the power supply following a maintenance procedure, remove the lockout/tagout device from the facility circuit breaker supplying power to the CV-12SLX. If not, proceed to Step 2.
1	Set the facility breaker switch to the ON position.
2	Set the circuit breaker switch (labeled AC MAINS) on the power module front panel to the ON position.
3	Set the FPS ON/OFF switch (see Figure 3-2) to the ON position.

Follow the operating instructions provided below to switch on and to adjust the HV, the filament bias current, and the emission current.

3.5 Control of Power Supply from a TemEBeam Controller (EBC)

3.5.1 Overview of the EBC's Operations>E-Beam Screen

If your system is equipped with a TemEBeam controller (EBC), you can use the **E-BEAM** button on its touch screen (see Figure 3-3) to switch the beam on and off. The **HV ON** and **Gun ON** buttons on the Operations>E-Beam screen allow you to switch the HV and gun on/off independently of each other. Note that if **kV Control** is set to **Input Ctrl** on the EBC's Config>E-Beam screen, then the **kV Set** button on the Operations>E-Beam screen allows the user to change the HV operating level from the default setting (10.0 kV). If **kV Control** is set to **Pot Ctrl**, then the **kV Set** button becomes a flat display rectangle like those labeled **Emission** and **Filament**, which indicate emission and filament current, respectively.

Figure 3-3 EBC's Operations>E-Beam Screen when Beam Is Off

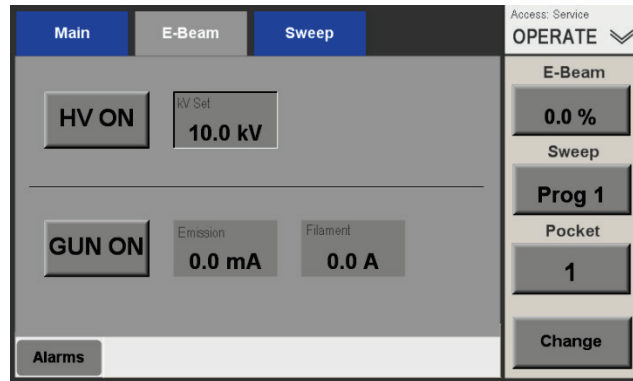

3.5.2 Using the E-BEAM ON/OFF Button to Switch the Beam On/Off

As noted above, when the beam is off you can switch it on by simply touching the **E-BEAM** button, assuming that you have already entered a nonzero percent-power setpoint. This applies when both HV and gun are off, when the HV alone is on, and when the gun alone is on. Touching the **E-BEAM** button when the beam is on switches the HV and the gun off. Figure 3-4 shows the Operations>E-Beam screen when the beam is on.

Figure 3-4 Operations>E-Beam Screen, Beam On at 0.0 mA

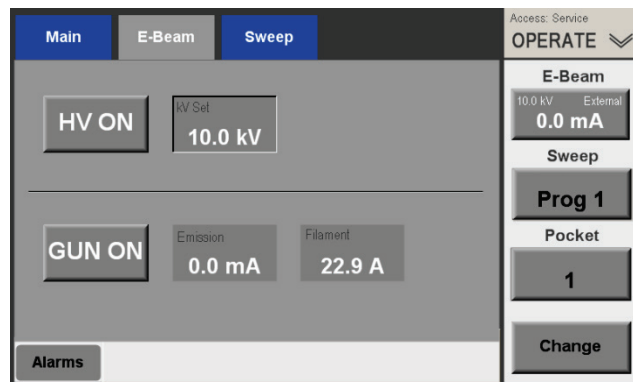

3.5.3 Switching on the HV and Gun Independently of Each Other

Figure 3-5 shows the Operations E-Beam screen when the gun is on but the HV is off. To switch the HV on/off independently of the gun, simply touch the **HV ON** button. Likewise, to switch the gun on/off independently of the HV, touch the **GUN ON** button. You can also switch on the beam by touching the **HV ON** and **GUN ON** buttons in either order.

Figure 3-5 Operations>E-Beam Screen when Gun is On and HV is Off

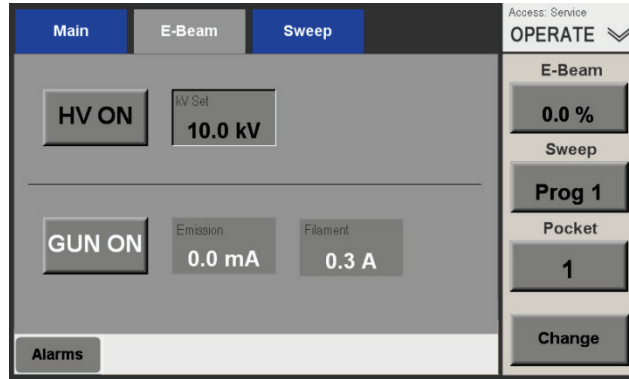

3.5.4 Setting the Beam Power Level

To set the beam power level, first touch the **Change** button, then touch the **E-Beam** button. The EBC will then display a keypad screen, which you can use to enter a percent-power setpoint. After you do so and touch **Enter** to close the keypad, the power supply will ramp up to that power setpoint. In Figure 3-6, the user has used the keypad to enter **5**. Figure 3-7 shows the Ops>E-Beam screen after the user has closed the numeric keypad, with the beam now operating at 5% power (= 75 mA). Note that the beam power level can be set or changed either with beam on or with it off.

Figure 3-6 Operations E-Beam Screen with Numeric Keypad Displayed

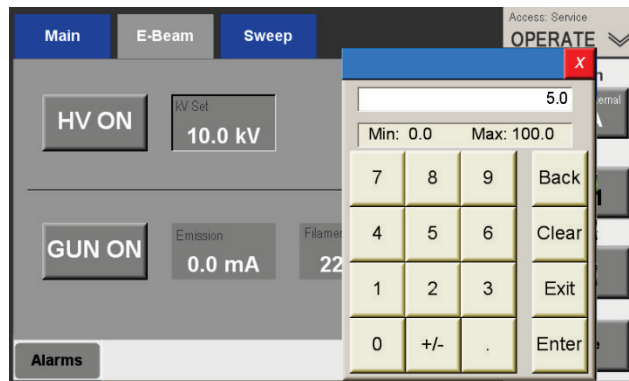
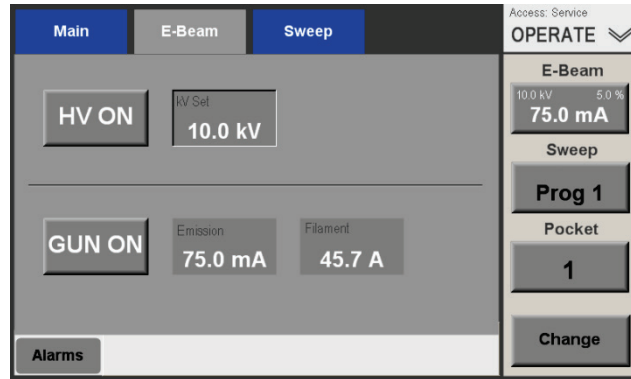

Figure 3-7 Operations>E-Beam Screen, Beam on at 5% Power



3.5.5 Changing the HV Operating Level

If **kV Control** is set to **Input Ctrl** on the EBC's Config>E-Beam screen, you can change the operating voltage of the HVPS at any time, regardless of whether the HV is on or off. To change the kV value:

- | Step | Action |
|------|--|
| 1 | Touch the rectangle labeled kV Set to open a numeric keypad. |
| 2 | Use the keypad to enter the desired kV value. |
| 3 | Touch the keypad's Enter button to close it. |

If the HV is on when you perform this procedure, the HVPS will begin operating at the new kV value as soon as you touch the **OK** button. If the button is off, the HV will begin operating at the new value the next time it is switched on.

3.5.6 Using the EBC's Diagnostics Screen

The EBC's Diagnostics screen (see Figure 3-7) enables you to monitor the operating status of the power supply from the EBC screen. Functional definitions of this screen's PS-related LED indicators appear below the screen illustration.

Figure 3-8 The EBC's Diagnostics Screen

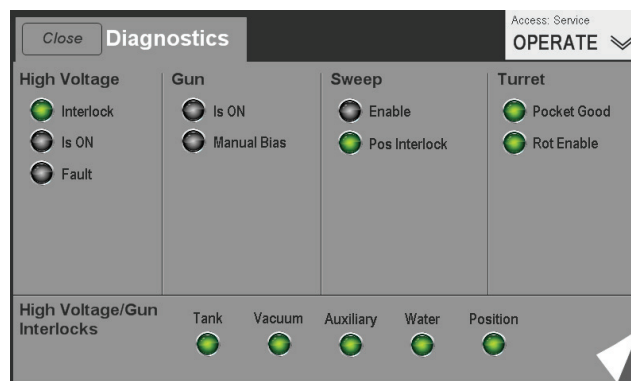

Functional Definitions of PS-Related LED Indicators on the Diagnostics Screen

Except where noted, the indicators on this screen are gray (off) when the signal in question is false and green when it is true.

High Voltage Section

- **Interlock** LED: Status of the HV interlock input from the HVPS
- **HV Ready** LED: Status of the HV READY input from the HVPS
- **HV is ON** LED: Status of the IS ON input from the HVPS
- **Fault** LED: On systems with CV6-SLX and CV12-SLX HV power supplies, this LED indicates the status of the HV FAULT input from the HVPS. It is green when that input is false and red when that signal is true, indicating that a latching power supply fault has occurred. For additional information about latching HVPS faults, see section 5.2.

Gun Section

- **Is Ready** LED: Status of the IS READY input from the FPS
- **Is ON** LED: Status of the IS ON input from the FPS
- **Manual Bias** LED: Off (gray) when autobias is selected via the Configuration>E-Beam screen and green when manual bias is selected.
- **Auto Bias** LED: Green when autobias is selected via the Configuration>E-Beam screen and off (gray) when manual bias is selected.

High Voltage/Gun Interlocks Section

The **Tank**, **Vacuum**, **Auxiliary**, **Water**, and **Position** LEDs indicate the state of the corresponding inputs from the HVPS and the FPS, which in turn reflect that state of the external interlock switches that must be made before the gun or HV can be enabled.

3.5.7 Switching the Beam On/Off and Setting Beam Power from the Remote Controller

Figure 3-8 shows how to switch the beam on/off and control beam power from the EBC's hand-held remote controller.

Figure 3-9 Remote Controller's LOCAL Screen, Menu 1 Selected, Beam and Sweep Off



3.6 Control of Power Supply by a PLC-Based System Controller

3.6.1 Switching Main Power On/Off

To switch on three-phase input power to the power supply, set the HVPS front-panel's main power breaker to the ON position (i.e., all the way up). To switch off main input power, set the main power breaker to the OFF position (i.e., all the way down).

NOTE

The main power breaker on the power module front panel controls power to the filament power supply (FPS) module. Switching the HV On/OFF and Adjusting the HV Level

Figure 3-10 shows the HVPS front panel LEDs when the unit is powered up and in its nominal state (i.e., no faults have occurred) but before the HV and the FPS have been switched on.

Figure 3-10 HVPS Front Panel LEDs: HVPS Powered Up in Nominal State, with HV and FPS Off

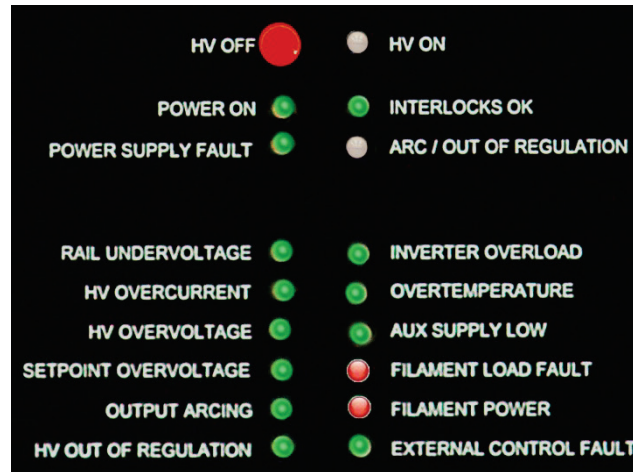

For additional information about HVPS front panel LEDs, see section 5.2.

3.6.2 High Voltage Control

Switching On the High Voltage Under Normal Operating Conditions

In order for the HV to be switched on, the LEDs on the HVPS front panel must be in the state shown in Figure 3-3. Then the external controller or control system must assert HV ON IN signal for two seconds at Pin 8 of HVPS rear panel connector J4 (see Table 2-1).

Switching On the High Voltage Following a Latching Fault Condition

Switching off the HV by pressing the HV OFF button on the power module front panel triggers a latching Power Supply Fault. In that event, or when any other latching fault has occurred, the following signals must be supplied, in the order given below, to switch the HV back on.

NOTE

If a Power Supply fault has occurred because of a latching fault condition—and not because the user has pressed the power module's HV OFF button—the underlying fault that triggered the latching fault must be corrected before the HV can be reset. For detailed information about fault indicator LEDs, see section 5.2. For diagrams illustrating the troubleshooting logic that applies to various fault conditions, see section 5.3. For troubleshooting procedures, see section 5.3.

1. The RESET signal must be supplied via Pins 10 and 11 of HVPS rear panel connector J4 (see Table 2-1). If the RESET attempt is successful, all status and interlock LEDs on the power module should be green, except for HV ON.

2. Assuming that the reset attempt is successful, the HV can then be switched on again. On units without a remote controller, the HV ON contact must be supplied via Pins 8 and 9 of HVPS rear panel connector J4 (see Table 2-1).

If this sequence of operations fails to restart the HV, refer to Table 6-5 for troubleshooting instructions.

Adjusting the High Voltage Level

If the REM/LOC IN signal supplied via J4 Pin 5 is low, the operator can adjust the HV by using a screwdriver to turn the OUTPUT KV ADJUST pot on the HVPS front panel (see Figure 3-1). If the REM/LOC IN signal is high, the external control system can adjust the HV by varying the HV SET IN input, which is supplied via Pin 1 of power module rear panel connector J4 (see Table 2-1).

Switching Off the High Voltage

The high voltage is automatically switched off if:

- any internal or external interlock is no longer made
- the power supply goes into an HV Out Of Regulation state
- a latching Power Supply Fault occurs.

If the REM/LOC IN signal supplied via J4 Pin 5 is low, the operator can switch off the HV by pressing the HV OFF button on the HVPS front panel (see (see Figure 3-1).

If the REM/LOC IN signal is high, the external control system can switch off the high voltage in either of two ways:

1. The control system can momentarily de-assert the HV ON contact supplied via Pins 8-9 of HVPS connector J4 (see Table 2-1).
2. The control system can assert the HV OFF contact supplied via Pin 17-18 of HVPS rear panel connector J3.

3.6.3 Switching the Filament Current On/Off

NOTE

In order for the filament current to be switched on, the FPS module's power cable must be properly connected to a source of 220-V ac power, and the module's ON/OFF switch must be in the ON position.

Switching On the Filament Current

The gun (i.e., filament current) can be switched on only by an externally supplied GUN GO ON signal, which must be applied via Pin 15 of FPS front panel connector J101 (see Table 2-2). Once HV and gun are both switched on, the emission current will ramp up to requested level after a 10–15 second delay.

Switching Off the Filament Current

In order for the filament current to be switched off, the GUN GO ON IN signal supplied via Pin 15 of FPS front panel connector J101 (see Table 2-2) must be de-asserted.

3.6.4 Adjusting the Filament Bias Current and the Emission Current

Adjusting the Filament Bias Current

The bias current can be adjusted only by varying the FILAMENT CURRENT REQUEST signal, which is supplied Pin 12 on the FPS front panel connector J101 (see Table 2-2).

NOTE

When the FIL BIAS SET SELECT signal (supplied via J101 Pin 5) is low, the Autobias circuit of the FPS controls the bias current. When the FIL BIAS SET SELECT signal is high, the operator can control the bias current from the control system's user interface.

Adjusting the Emission Current

The emission current can be adjusted only by varying the EMISSION CURRENT REQUEST signal, which is supplied via Pin 10 FPS rear panel connector J101 (see Table 2-2).

3.7 Responding to Fault Conditions

3.7.1 Responding to Latching Power Supply Faults

The following signals must be supplied, in the order given below, in order for the HV to be switched back on after a latching Power Supply fault has occurred:

- a RESET signal, supplied either by the user pressing the front panel HV OFF button or by remote input, via Pins 10 and 11 on HVPS rear panel connector J4
- an HV ON input, supplied via HVPS J4 Pins 8 and 9.

The remote HV ON signal can be supplied either from an EBC (see section 3.5) or from a PLC-based system controller. In many cases, it will be necessary to trace and correct the cause of a latching fault before the HV can be switched back on. Then the RESET and HV ON signals must be supplied, as described above. Note that the gun is not automatically switched off when latching Power Supply (i.e., HVPS faults occur) and that FPS faults that cause the gun to be switched off do not cause the HV to be switched off. Section 3.7.2 describes this user-response sequence with respect to a specific latched-fault condition.

For detailed functional descriptions of the front panel LEDs that indicate latching faults, see section 5.2.3. For diagrams illustrating the troubleshooting logic that apply to a various fault conditions, see section 5.3. For detailed troubleshooting procedures, see section 5.4.

3.7.2 Special Note Regarding Arc-Related Fault Conditions

During normal operation, the **ART/OUT OF REGULATION** LED on the power module front panel will flash intermittently as arcs occur. The flashing will increase in frequency as arcs increase in frequency. Each time it does so, the **HV OUT OF REGULATION** LED will also turn amber for two seconds. For an illustration of this Subthreshold arcing state, see Figure 3-11.

Figure 3-11 HVPS Front Panel LEDs when Subthreshold Arcing is Occurring

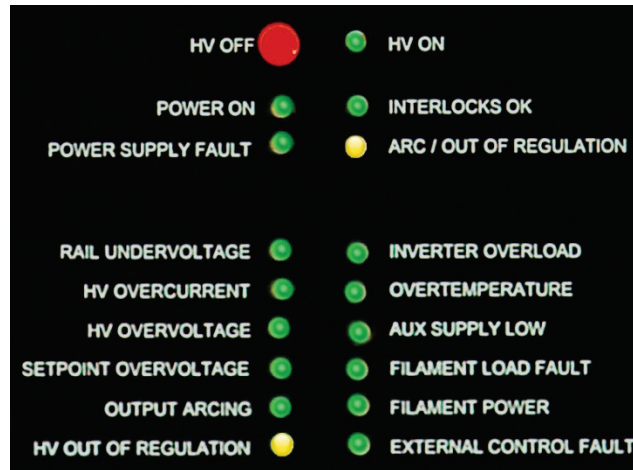

If arcing surpasses either a frequency or a time-duration threshold, a latching **OUTPUT ARCING** fault will occur. (These threshold values are detailed in Figure 5-6.) The **OUTPUT ARCING** and **POWER SUPPLY FAULT** LEDs will then light red, while the **HV OUT OF REGULATION** LED will turn green and the **ARC/OUT OF REGULATION** LED will no longer flash. In addition, the **HV ON** LED is extinguished, as the fault condition causes the HV to be switched off. This latched-fault state is illustrated in Figure 3-12.

Figure 3-12 HVPS Front Panel LEDs when a Latched OUTPUT ARCING Fault Has Occurred

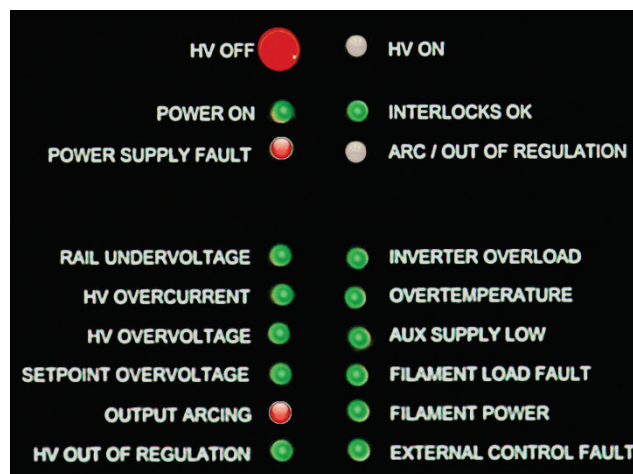

If the **OUTPUT ARCING** fault occurred solely because intermittent arcing passed one of the threshold conditions, the HV should come back on as soon as the RESET and HV ON signals are supplied. Out-of-regulation faults arising as a result of other conditions will likely require troubleshooting. To address such cases, see Ishikawa Diagram #11 and Table 5-16.

4

Theory of Operation

4.1 Section Overview

This section provides separate theories of operations for the major modules of the CV-12SLX power supply. Section 4.2 contains a theory of operation for the power module (i.e., HVPS) and section 4.3 covers the FPS in detail.

4.2 HVPS Theory of Operation

4.2.1 Input Power Filtering, Protection, and Distribution

AC line power is connected to the power module through rear-panel AC INPUT terminals (see Figures 4-1 and 4-2). Line filter LF1 then performs high-frequency filtering to minimize conductive emissions from the unit and to protect against AC line transients at common levels. The load side of LF1 feeds three-phase circuit breaker CB1 as well as the J2, the filtered rear-panel IEC auxiliary outlet (see Figures 4-1 and 4-2). Circuit breaker CB1 is mounted to the front panel and shielded from inadvertent operation by a “kick” guard. CB1 provides overcurrent protection for the three AC line phases, and its load side feeds the Inverter board. Rear panel AC outlet J2 is fused at 6.3A by F1 and F2, which are accessible via the rear panel through panel-mounted fuse holders (see Figures 4-1 and 4-2). On 208 VAC units, outlet J2 is connected between phases, while on 400 VAC units it is connected between one phase and neutral. The goal is to maintain the J2’s voltage between 187 VAC and 254 VAC, taking into account the $\pm 10\%$ tolerance range of the voltage supplied to TB1.

Figure 4-1 Single-Gun CV-12SLX HVPS Rear Panel

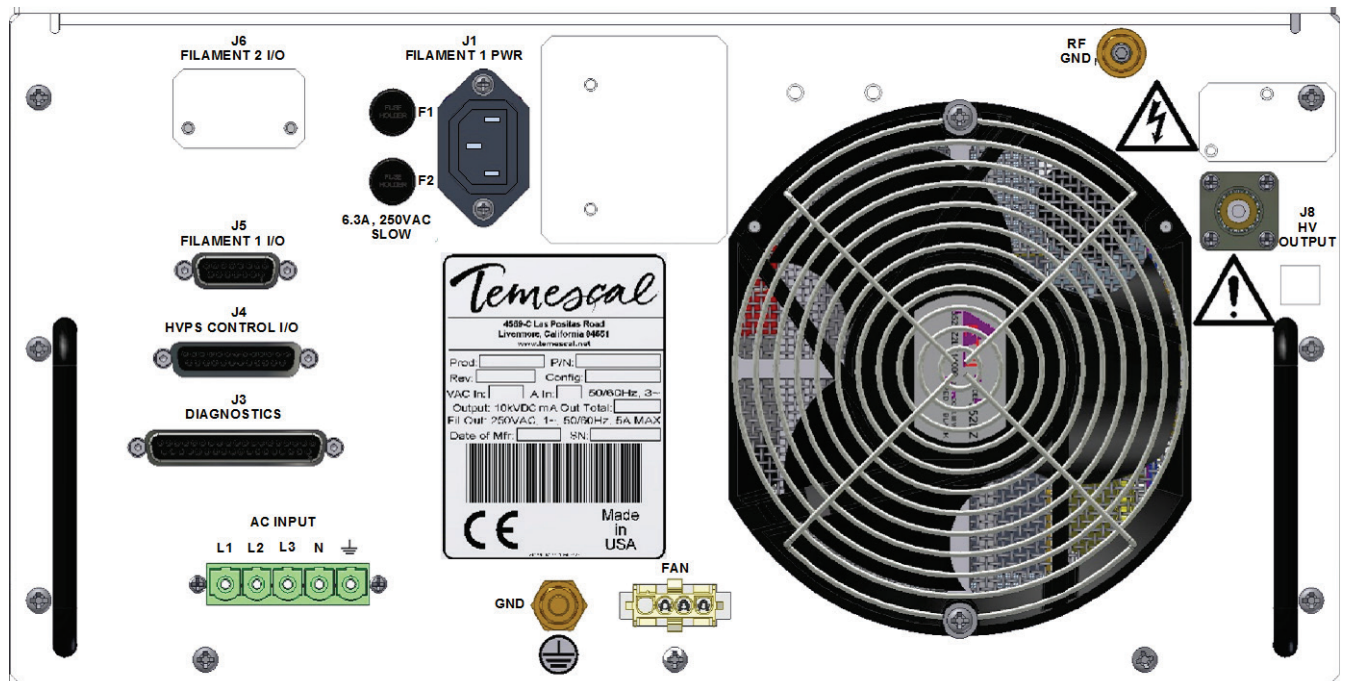
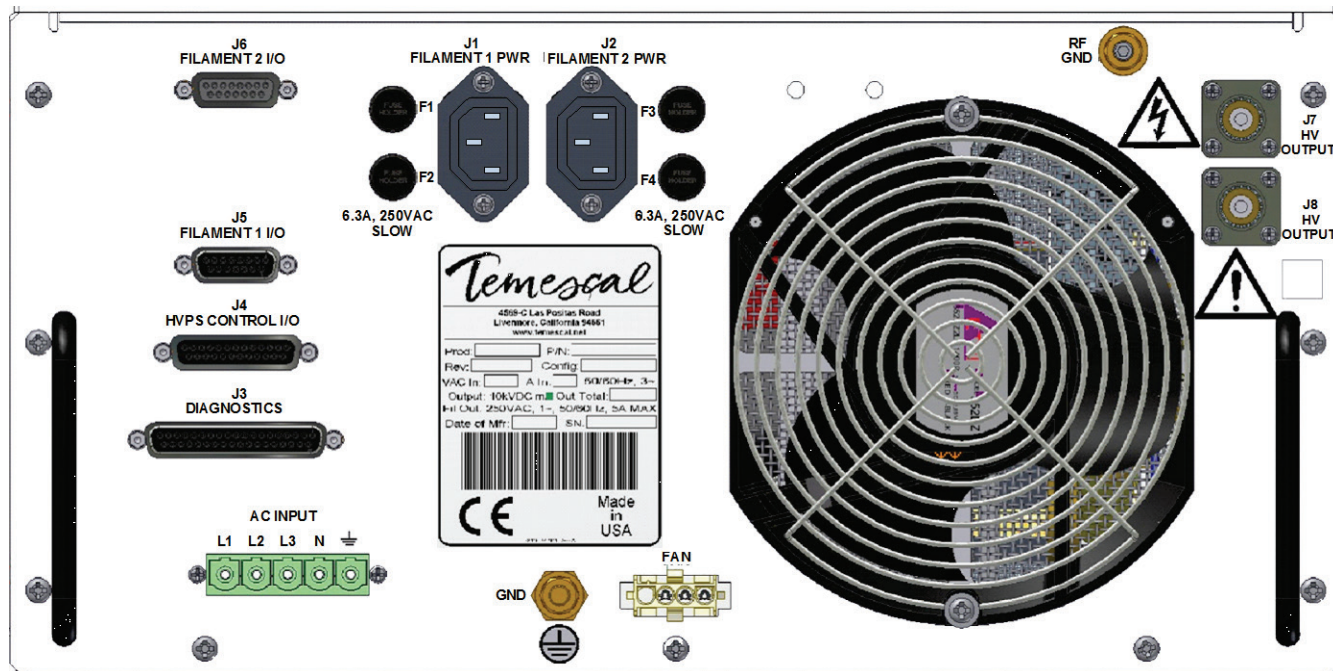

Figure 4-2 Dual-Gun CV-12SLX HVPS Rear Panel



Two AC line phases from the Inverter board feed the primary of step-down transformer T2. In 208 VAC units, T2 is wired with jumpers for a 1:1 ratio. In 400 VAC units, it is wired for a 2:1 ratio. T2 powers the AC input of PS1, the +24 VDC auxiliary power supply. The +24 VDC output of PS1 connects back to the Inverter board and provides low-voltage power to the other board assemblies in the power module.

4.2.2 Power Module Grounding

Grounding is provided through two threaded studs mounted on the unit's rear panel (see Figures 4-1 and 4-2). The grounding stud labeled GND must be connected to an earth ground for safety. The other threaded grounding stud, labeled RF GND, provides a ground return for the HV output and must be properly connected to provide a low-impedance ground (for instructions, see section 2.5.1). Internally, ground wires are connected together by a ground block mounted to the bottom panel.

4.2.3 Temperature Control

Temperature inputs come from two separate devices, thermostat S2 and IC sensor U1, which are connected to the Inverter board. Thermostat S2 opens when the Inverter board's heat sink rises above a preset temperature. U1 generates an analog voltage scaled to the temperature of the heat sink near the Inverter board's IGBTs. Both sensors feed the over-temperature fault circuitry. Cooling of internal components is provided by +24 VDC fan B1 mounted on the rear panel. The fan draws air in through the front panel grille and exhausts it through the rear of the unit. The fan features an integral jammed-rotor sensor, which is designed to sense when the fan has stopped spinning and to trigger an over-temperature fault in that event.

4.2.4 PCB Functionality

Inverter Board

From the load side of circuit breaker CB1, the three AC line phases are fed to the Inverter board, which converts the 50/60Hz AC line power into high-frequency power. Part of that conversion process involves rectifying the AC input voltage through a three-phase bridge rectifier and employing a “DC link” choke (L1) to smooth the current. This inductor improves the power factor of the power module as seen by the AC power grid. High-speed IGBTs on the Inverter board switch the rectified bus voltage through HV transformer T1 at 25 kHz, thereby converting the intermediate DC power once again into AC power. Other functions performed by the Inverter board are rail capacitor charging, temperature sensing, and monitoring auxiliary power and rail voltage.

HV Rectifier Board

The HV Rectifier board converts the high-frequency, high-voltage output of HV transformer T1 into DC high-voltage power. The Rectifier board also scales the output voltage and current for feedback to the Regulator board’s control circuits.

HV Output Board

The HV Output board provides secondary-tuning capacitance, HV rectification, and voltage and current feedback to the Regulator board. High frequency AC voltage driven on the primary of the HV transformer by the Inverter is transformed by a fixed ratio (15:225) and connected to the input of the HV Output board at J1 and J2.

Regulator Board

The Regulator board performs virtually all logic, control, and analog processing functions. However, its primary function is output voltage control. The board performs this function by comparing the output feedback to the references provided and then feeding the Inverter board’s IGBT gate drives to properly actuate them. DC output voltage is delivered from the Regulator board to the external load through the custom high-voltage “cablewell” connector J1 on the unit’s rear panel. A mating connector and cable for J1 are provided with each power supply.

Interface Board

The Interface board is mounted to the upper left-hand corner of the rear panel. Three D-subminiature connectors on the Interface board connect the remote I/O signals to the Regulator board. J1, a 14-pin D-sub connector (labeled J5 on rear panel), provides the interface to the filament power supply. J2, a 37-pin D-sub connector (labeled J3 on rear panel), provides diagnostic signals to the user’s system. Appendix B provides a pinout table for these signals. J3, a 24-pin D-sub connector (labeled J4 on rear panel), serves as the active control interface for user-supplied I/O signals.

Interface board connector J4 routes all signals on the Interface board to the Regulator board. Since the location of the unit's top cover interlock switch (which opens its contacts when the top cover has been removed) is adjacent to the Interface PCB, board connector J5 provides the shortest path for the switch's contacts to the interlock circuitry on the Regulator board.

Display and Control Board

The Display and Control board is sandwiched between the front panel and the Regulator board. The Display and Control board houses and handles signals to/from an HV OFF pushbutton, an output voltage adjustment potentiometer, voltage and current LCD displays, and the unit's front panel LEDs.

4.3 FPS Theory of Operation

4.3.1 Overview of FPS Operation

The filament power supply module (see Figure 4-3) provides emission current control and measurement, filament power and control, and high-voltage switching. The filament circuit utilizes high-frequency switch mode technology similar to that of the high-voltage circuit. The filament circuit requires single-phase power of approximately 208–230 V.

Figure 4-3 Filament Power Supply (FPS) Module



Figure 4-4 shows the locations of the major components in the standard FPS unit (i.e., FPS

modules with PNs 0620-6604-0 and -1). Figure 4-5 is a top-level block diagrams that applies to those FPS modules. Figure 4-6 shows internal component locations in FPS units with PN 0620-6604-2. Figure 4-7 is a functional block diagram for those units. In all three variants, primary power enters the FPS via J302 and is routed to the Filament Supply PCB. The FPS consists of two major functional sections, the Filament Supply PCB and the Filament Output section. The Filament Supply Board supplies and controls the filament power. The filament output section combines the filament power with the negative HV from the power module and routes the combination to the filament. As Figure 4-5 shows, the Filament Output section on standard FPS units consists of an HV vacuum relay and a filament transformer. On FPS units with PN 0620-6604-2, the Filament Output section consists only of a filament transformer (see Figure 4-7). Section 4.3.4 describes the Filament output section in greater detail.

4.3.2 Safety Interlocks

The safety interlocks insure that circuits are safely connected and that the box is closed before operation can continue. Safety interlocks are provided by switches S101 and S102 in the filament output section of the FPS. These interlocks are routed to the Filament Supply PCB via J103 pins 3 and 4 and are connected in series with the cover interlocks on the CV-12SLX power module. Therefore, in order for FPS operation to take place, the FPS covers and the power module covers must be in place, closing the interlock switches, and the FPS cover interlock switches must be connected to the Filament Supply PCB.

Figure 4-4 Component Location in Standard FPS Units (PN 0620-6604-0 and -1)

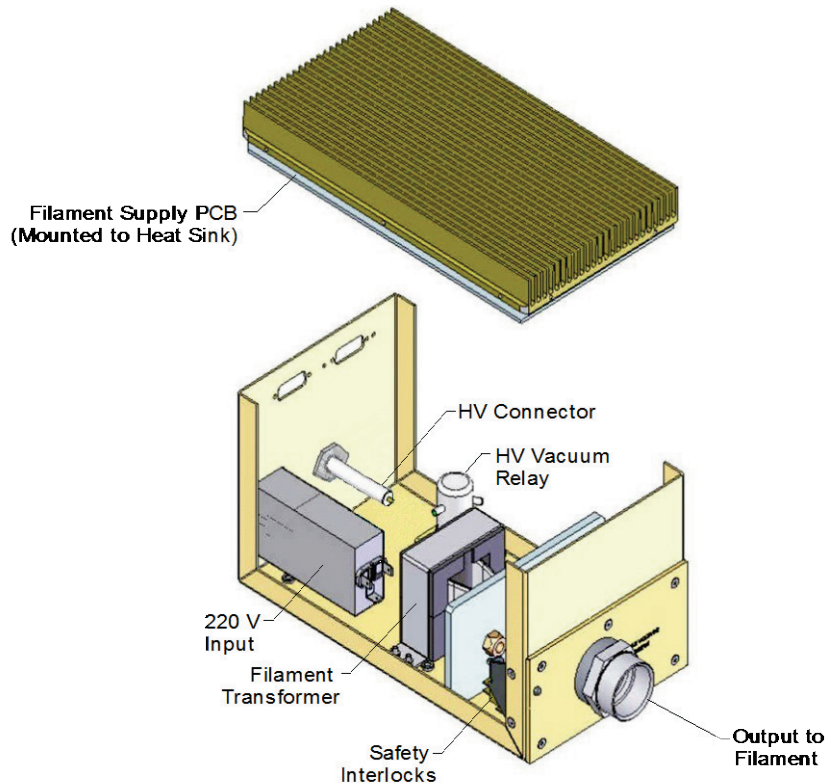

Figure 4-5 Top Level Block Diagram for Standard FPS Units (PN 0620-6604-0 and -1)

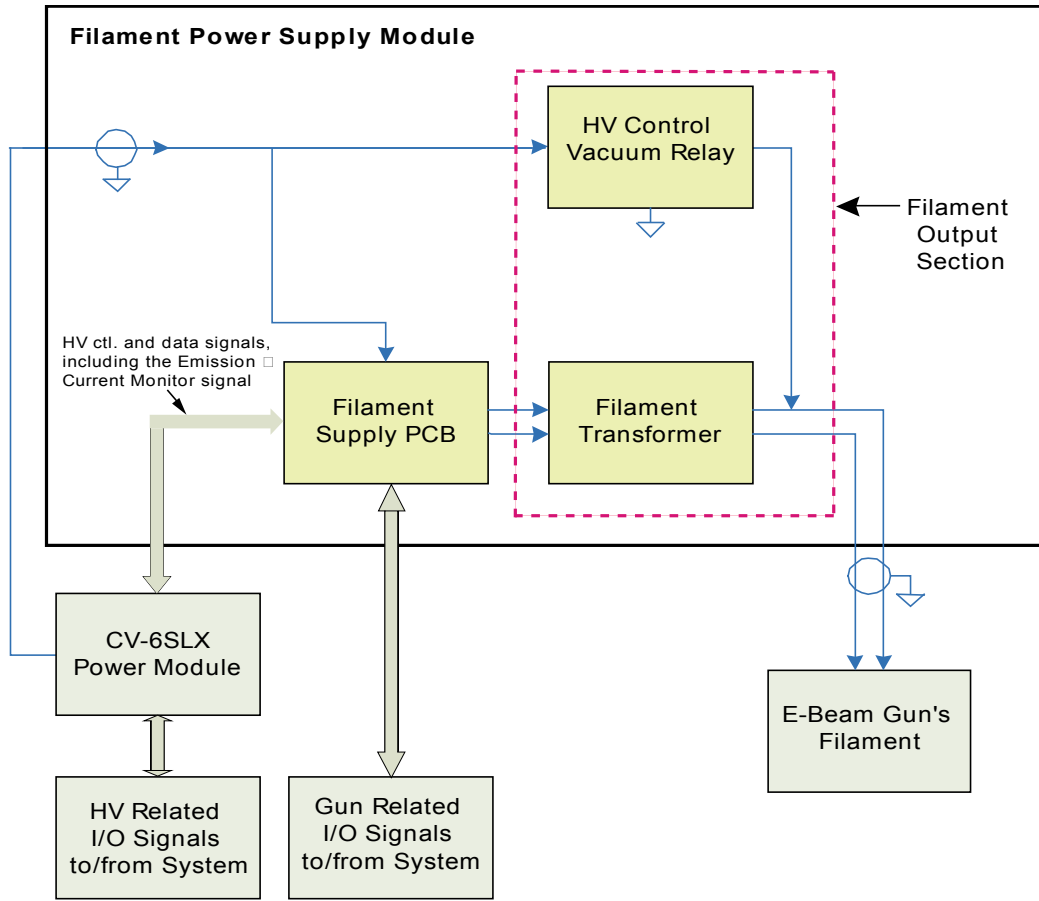

Figure 4-6 Component Location in FPS Units with PN 0620-6604-2

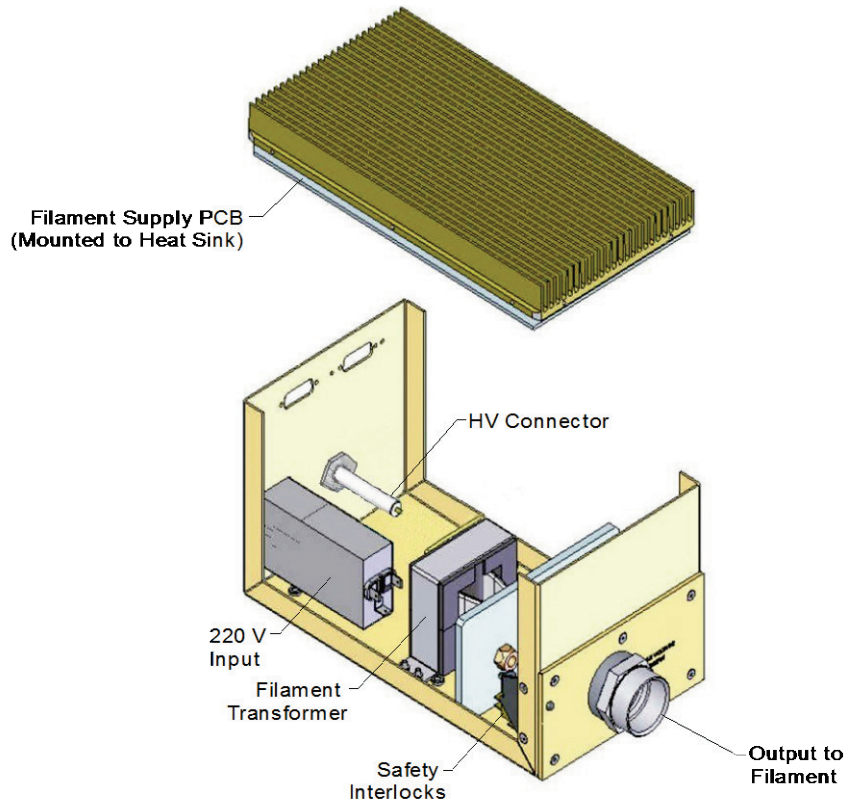
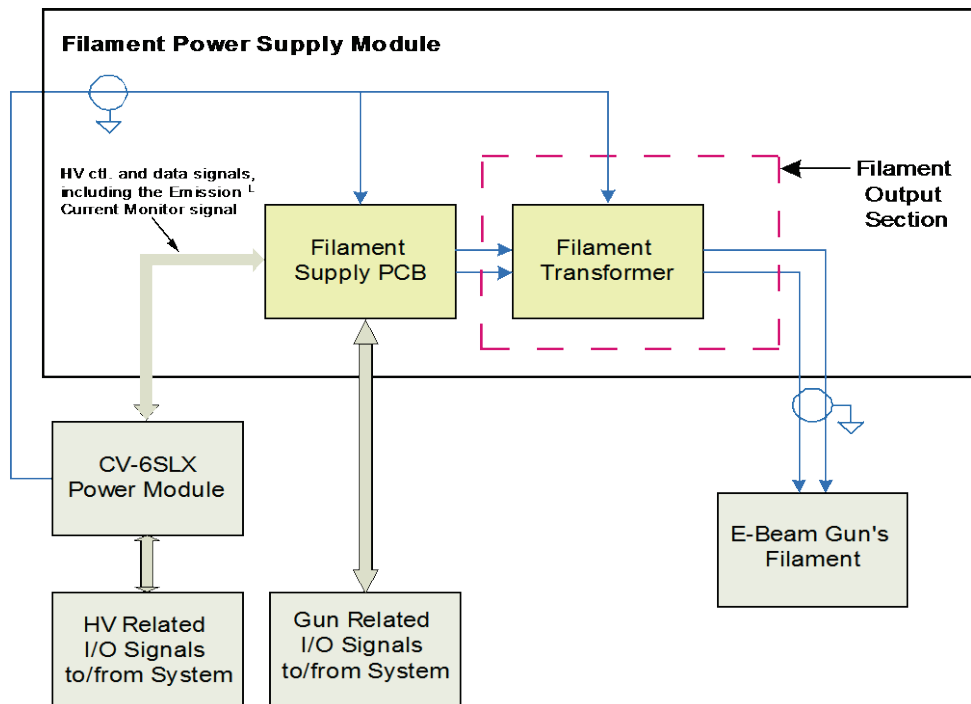

Figure 4-7 Top Level Block Diagram for FPS Units with PN 0620-6604-2



4.3.3 Filament Supply PCB

Figure 4-8 is a top-level block diagram for the Filament Supply PCB, whose circuits are described in detail below.

Figure 4-8 Filament Supply PCB Overview Block Diagram

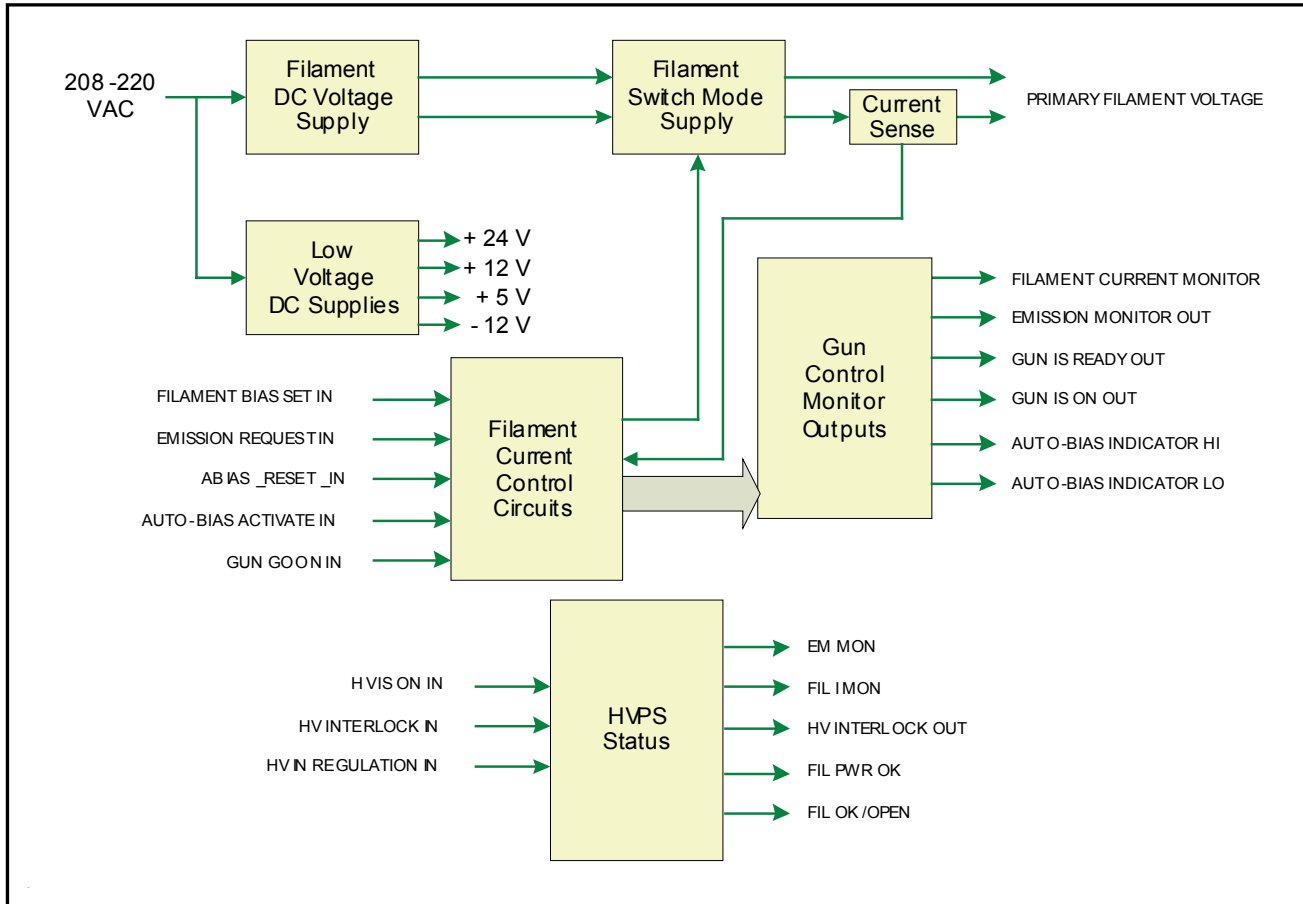

Filament DC Voltage Supply for Switch Mode Converter

A single-phase bridge rectifier circuit provides the raw dc power for the high-frequency switches. The DC voltage is filtered and a + (positive) rail voltage and a - (negative) rail voltage is established. The single-phase 220-V power for the filament and positions circuits enters on J104 Pin 1 and 4. The circuit is protected by fuses F-1 and F-2. The ac power is rectified by DB-10 and filtered by inductors L-10 and L-11 in combination with rail capacitors C-11 and C-12.

Low-Voltage DC Supplies

Low DC voltages of +24 V, +12 V, +5 V and -12V are supplied by T-102 via bridge rectifiers DB-14 and DB-14. +12 V and +5V are down-regulated from +24 V by VR-101 and VR-103. -12 V is down-regulated from -24 V by VR-102. These supplies provide power for the logic and control circuits on the board.

Filament Switch Mode Supply

The filament supply uses IGBT switches and operates at a frequency of approximately 28.5 kHz. The filament transformer steps down the voltage with a ratio of 10:1 to provide approximately 10 V rms at the filament. There are no rectifiers on the output of the transformer as the filament input is high frequency AC. The filament circuit is current-regulated. There are two modes of filament operation: One with HV OFF and one with HV ON.

A. HV OFF

Filament Reference: Filament Bias Set

Filament Feedback: Filament Primary Current

B. HV ON

Filament Reference: Autobias (if active)/Emission Current Set

Filament Feedback: High Voltage Current

The filament switch mode supply IGBT switches Q-10 and Q-11 switch the primary of the filament transformer between the voltage rails at a frequency of approximately 34 kHz. The filament transformer connects to the center point of the rail capacitors. Thus, half of the rail voltage is impressed alternately on the transformer by the IGBT inverters. Gate driver ICs U-10A and U-10B, in conjunction with transformer T-101, provide the gate drive for the IGBT switches. Inductor T-103 has a dual function of adding impedance in the primary and a sensing circuit for fault currents. Capacitors C-20 through C-24 are tuning capacitors for the output circuit.

The IGBT switches are driven from the PWM modulator chip U-101. This IC has two outputs. One output drives IGBT switch Q-10 and the other drives IGBT switch Q-11. The PWM is controlled by the filament current control circuits. The filament current feedback circuit utilizes transformer CT-10 to measure the filament transformer primary current. The signal is rectified by DB-11 and scaled by A-102. The feedback signal scaling is $4.0 \text{ V} = 50 \text{ A}$.

Filament Current Control Circuits

Filament Current Control Loop

Figure 4-9 shows a block diagram of the control and power circuits. As that diagram shows, the filament current is regulated by filament current feedback or emission current feedback. The analog OR circuit (U-106B, along with D-13A and D-13B) selects emission-current regulation or filament-current regulation, depending on which request signal is greatest.

Assume that Filament Current Request (FCR) is asserted and Emission Current Request (ECR) is zero and that Auto Bias Enable is not asserted. The scaling for FCR is 0 to 4.0 volts = 0 to 50.0 amperes. FCR is buffered by A-103 and fed via analog switch A-104B and buffer inverter U-205B to the summing junction at the input to the filament current loop compensation amplifier U106A. The output of U106A feeds the PWM U101 via buffer U106B to drive the switch mode power inverter. The filament feedback signal from buffer A102 is fed to the summing junction at the input to the filament current loop compensation amplifier (U106A). Ideally, the FCR level will be just below the point where emission current takes place, therefore when zero emission current is called for FCR will dominate. An alternative to FCR to drive the filament current loop is auto bias. Analog switches A104A and U104B form an SPDT switch that selects either FCR or the Auto Bias signal as the input to the filament current summing junction. The Auto Bias circuit is described in greater detail below.

Figure 4-9 Block Diagram of Filament Supply PCB Control and Power Circuits

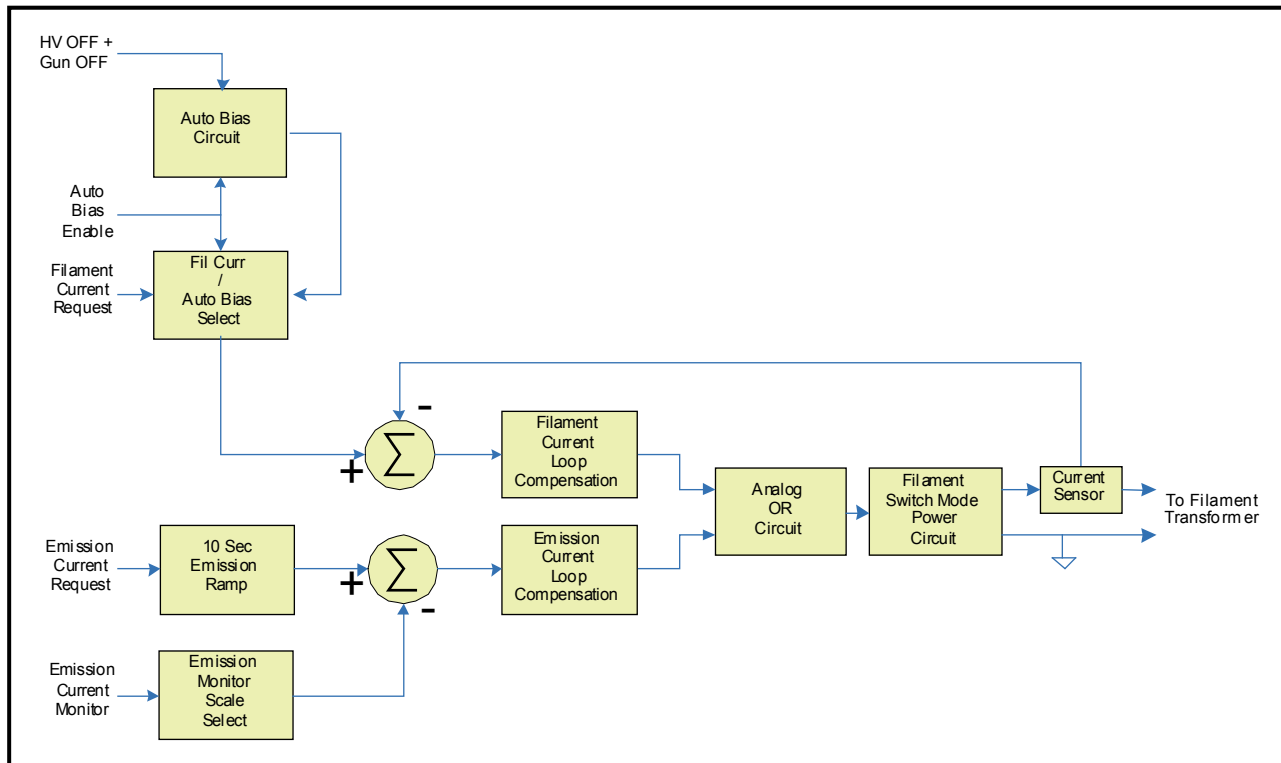

Emission Current Control Loop

When emission current (ECR) is called for the emission current loop control comes into play and the filament current control loop is ignored. ECR is first buffered by A105 and then fed to the 10-sec ramp circuit to gradually increase the emission current to the desired level. The output of the ramp circuit U103-2 is fed to inverting buffer U205A to the summing junction of the emission current loop compensation circuit of U106A via R54. The emission current feedback signal, Emission Monitor (EM) comes from the HV current transducer in the Filament Output Section of the FPS and is scaled by a rotary switch selection of gain values for buffer A101. The output of A101 is also fed to the summing junction of the emission current loop compensation circuit of U106A via R52. As above, the output of U106A feeds the PWM U101-2 via buffer U106B to drive the switch mode power inverter.

Emission Current Request Ramp

Figure 4-10 is a block diagram for the emission current ramp circuit, which allows the gradual increase of emission current in 255 steps. When the Emission Request, Gun On, HV On, and HV In Reg signals are asserted, clock U104 begins clocking 8-bit counter U11 from its cleared state. When U11 counter reaches 255, the AND of its outputs stops the clock oscillator. The eight outputs of the counter drive the 8-bit digital to analog converter U103. The output of the D/A is the count times the Emission Current Request Signal divided by 256.

Figure 4-10 Emission Current Ramp Circuit

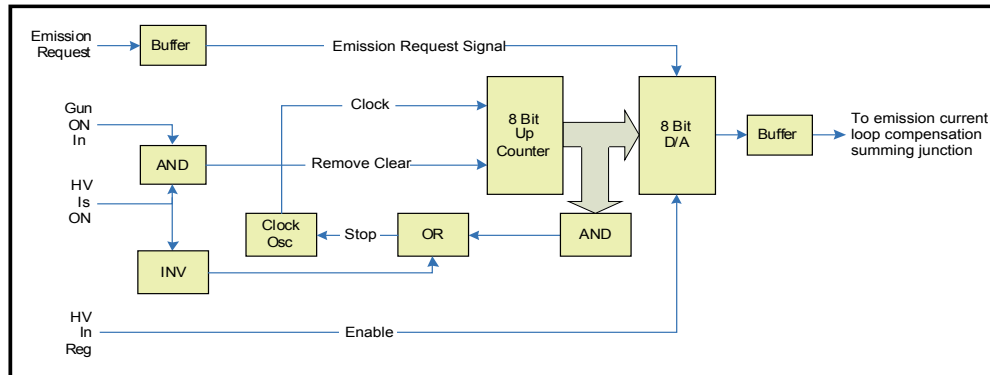

Auto Bias Circuit

Figure 4-11 shows the Auto Bias circuit, which is designed to maintain the filament current at a level just below the zero emission current point. To do so, the Auto Bias circuit gradually increases the filament until emission current begins to flow. When this is detected, the emission current is scaled back to a point just below emission threshold. The process begins with Gun ON and HV ON asserted and with Auto Bias invoked. As noted above, switches A104A and A104B form an SBDT switch that selects either the filament current request or the Auto Bias signal as the input to the filament current loop compensation summing point. Selection by this SBDT switch of the Auto Bias signal also removes the clear from counter U101 and clears the stop from clock oscillator U203, allowing it to clock the counter. The counter outputs drive the 8-bit D/A converter U202. The D/A output is Ref times the count divided by 256 volts. This count-up process continues until Emission Current is above the threshold, as determined by comparator U102C. The comparator output sets the latch U16B Auto Bias Set. The latch output stops clock U203 and slightly reduces the gain of scaling amplifier U105B via analog switch A104C, setting the autobias level just below the emission point.

Figure 4-11 Autobias Circuit Block Diagram

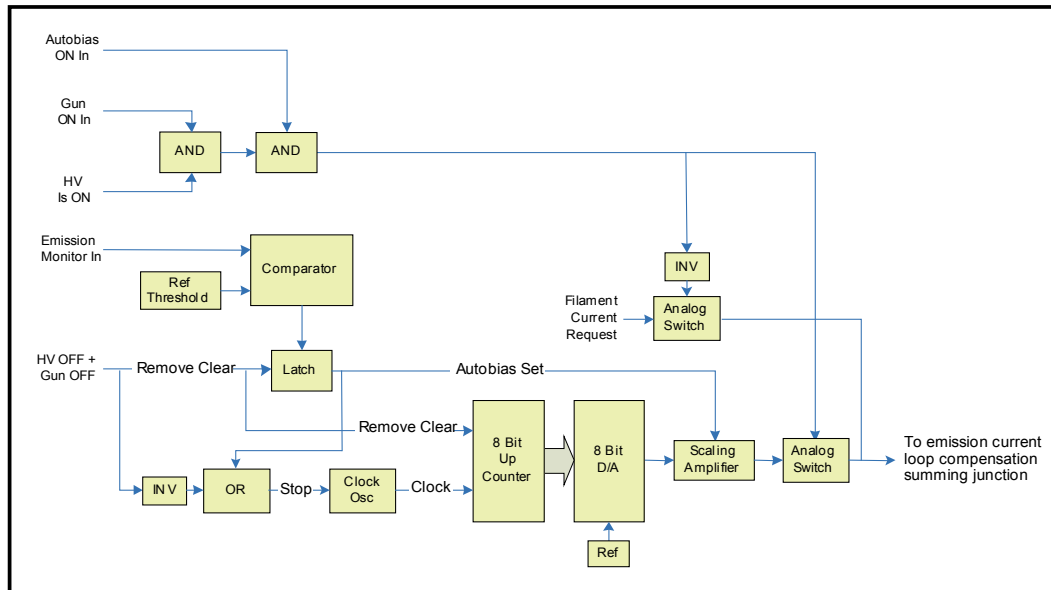

4.3.4 Filament Output Section

The filament output section of the FPS connects the filament power with the negative HV. The filament power and the HV are connected to the filament by a two-conductor cable. The high voltage (0–10 kV) from the HV Power Supply enters the FPS via J301. On standard FPS units (PN 0620-6604-0), the high voltage is routed to the vacuum relay (K101). On such units, K101 either connects the negative HV to the secondary of the filament transformer or applies a ground to the secondary of the filament transformer. The relay is driven from the Filament Supply PCB via J103 pins 5 and 6.

FPS units with PN 0620-6604-0 omit the vacuum relay. On those units, the high voltage is connected to the secondary of the filament transformer T1, which has a 10:1 ratio. The filament transformer connects the high-voltage, low-current output of the FPS to the filament with low-voltage, high-current filament current, superimposing the negative DC HV on the AC filament current.

5

Troubleshooting

5.1 Section Overview

This section provides a guide to basic troubleshooting procedures. The topics covered are:

Section 5.2 HVPS Front Panel LEDs

Section 5.2.1 Status Indicator LEDs

Section 5.2.2 LEDs That Indicate Nonlatching Faults

Section 5.2.3 LEDs That Indicate Latching Faults

Section 5.3 Ishikawa Diagrams

Section 5.4 Troubleshooting Procedures

Section 5.4.1 Checkout of HV Circuit and Cable Connections

Section 5.4.2 Troubleshooting Tables

Section 5.5 FPS Fuse Replacement Procedure

Section 5.6 Suggested Spare Parts

In some cases, the user will be able to resolve a given problem by such simple measures as ensuring that cable connections are properly made or ensuring that the turret on multipocket sources can turn freely. In other cases, the information provided in this section will aid the user to narrow down the source of a problem to a small number of possible causes. In some cases, it will be necessary to contact Temescal Field Service for assistance in resolving the problem.

5.2 HVPS Front Panel LEDs

Except when power is lost, the LEDs on the HVPS front panel (see Figure 5-1) indicate the current operating status of the power supply. Section 5.2.1 describes the LEDs that are pure status indicators. Section 5.2.2 describes the LEDs that indicate nonlatching faults (i.e., faults that do not switch off the HV), and section 5.2.3 describes the LEDs that indicate latching faults.

Figure 5-1 HVPS Front Panel LEDs

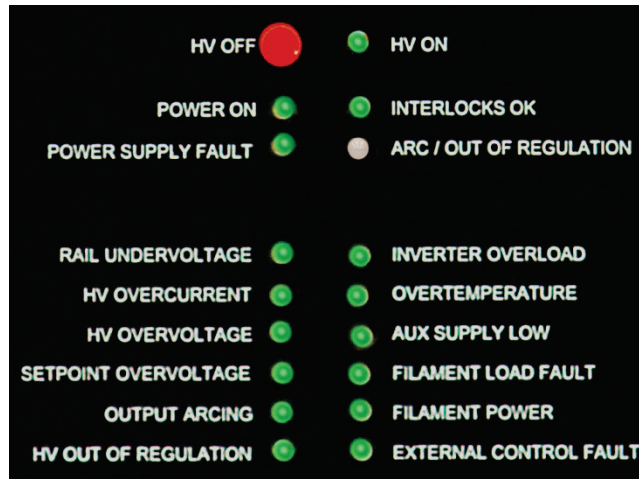

5.2.1 Status Indicator LEDs

Figure 5-2 points out and describes the three status indicator LEDs.

Figure 5-2 Status Indicator LEDs

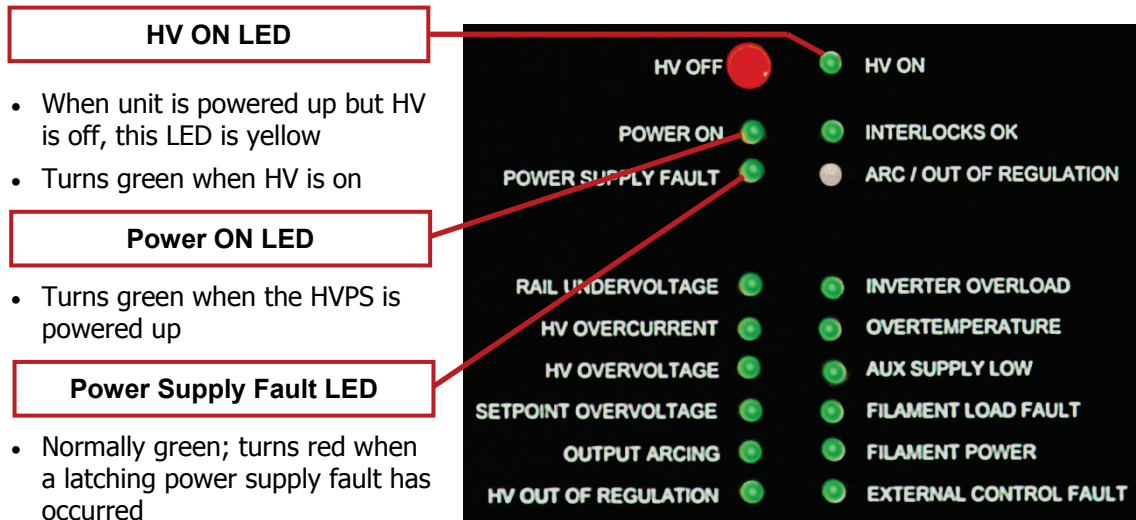

5.2.2 LEDs That Indicate Nonlatching Faults

Figures 5-3 and 5-4 point out and describe the front panel LEDs that indicate nonlatching faults (i.e., faults that do not cause the HV to be switched off). They are:

- Arc/Out of Regulation
- HV Out of Regulation
- Filament Power
- Filament Load Fault

Figure 5-3 Sub-Threshold Arcing: Arc/Out Of Regulation and Output Arcing LEDs

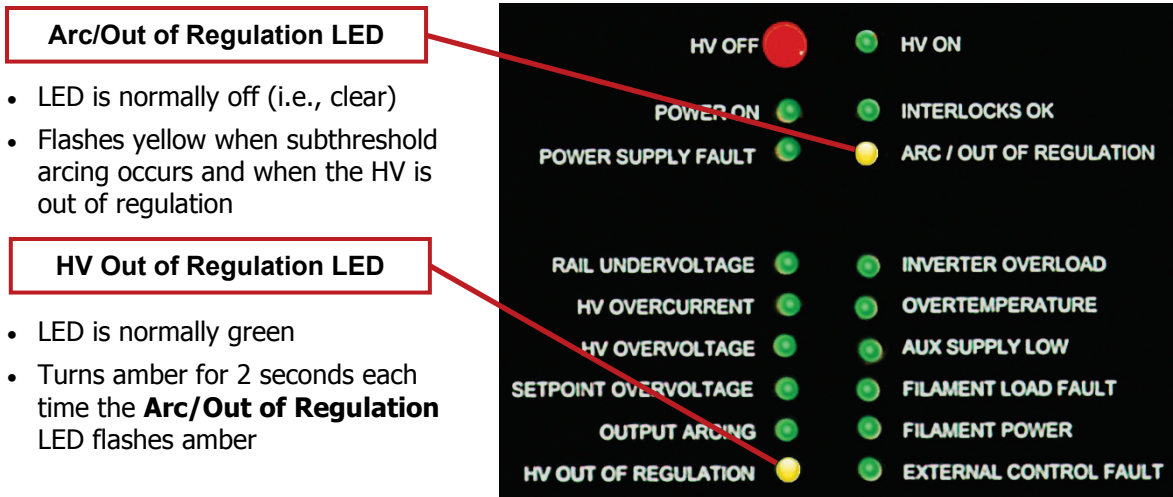

NOTE
 Figures 5-4 and 5-6 through 5-10 do not show HVPS LEDs as they would appear when the applicable faults have occurred. Instead, the LEDs described in these illustrations are shown as red merely to highlight them.

Figure 5-4 Filament Load Fault and Filament Power LEDs

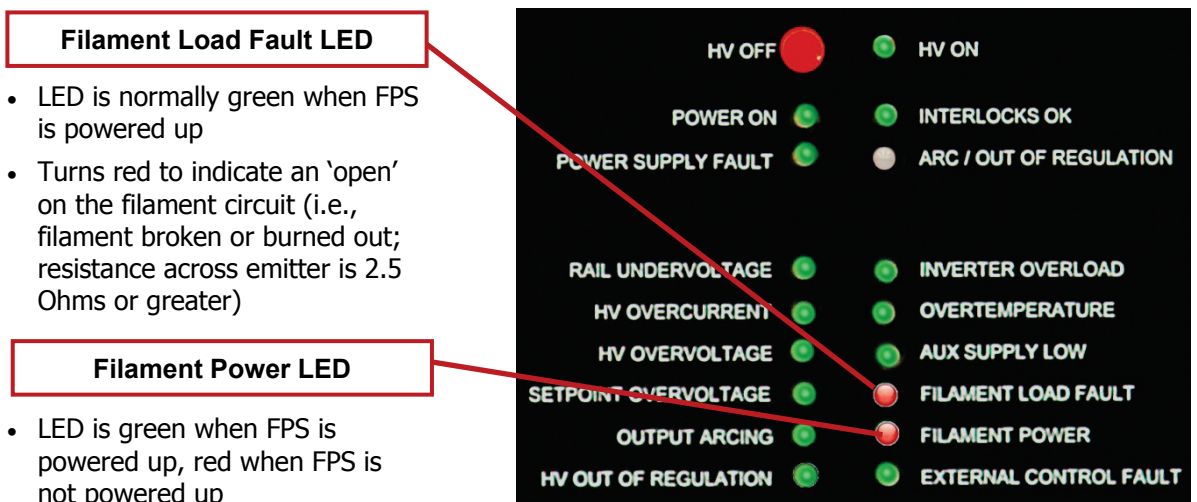

NOTE
 The HV can remain on, even if the gun is switched off, either due to a fault or user action.

5.2.3 LEDs That Indicate Latching Faults

Figures 5-6 through 5-10 point out and describe the front panel LEDs that indicate latching

faults. Those LEDs are outlined in Figure 5-5.

Figure 5-5 HVPS Front Panel LEDs with Latching Fault LEDs Outlined

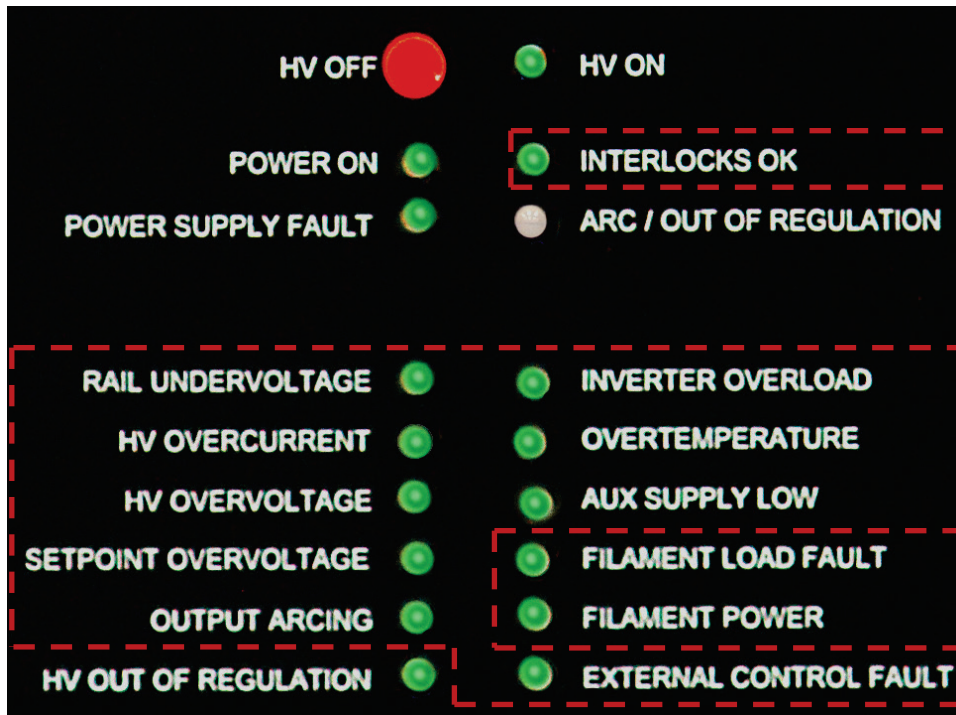

Figure 5-6 Interlocks OK and Rail Undervoltage LEDs

Interlocks OK LED

- Turns red one or more interlocks (internal or external) are not met

Rail Undervoltage LED

- LED turns red if the rail voltage falls below the value specified below:
 208-V units: 220 VDC (Nominal range is 264 to 323 VDC)
 400-V units: 427 VDC (Nominal range is 509 to 622 VDC)

Figure 5-7 HV Overcurrent and HV Overvoltage LEDs

HV Overcurrent LED

- LED turns red if output current is more than 105% (630 mA– 636

HV Overvoltage LED

mA) of maximum output current (600 mA)

- LED turns red if HV output exceeds 10.5 kVDC

Figure 5-8 Setpoint Overvoltage and Output Arcing LEDs

Setpoint Overvoltage LED

- LED turns red if actual HV output varies from nominal requested HV setpoint value by more than 5%

Output Arcing LED

- LED turns red if the arc rate exceeds threshold value of 200 arcs/sec or if subthreshold arcing persists for more than 120 sec.

HV OFF ●	HV ON ●
POWER ON ●	INTERLOCKS OK ●
POWER SUPPLY FAULT ●	ARC / OUT OF REGULATION ●
RAIL UNDERVOLTAGE ●	INVERTER OVERLOAD ●
HV OVERCURRENT ●	OVERTEMPERATURE ●
HV OVERVOLTAGE ●	AUX SUPPLY LOW ●
SETPOINT OVERVOLTAGE ●	FILAMENT LOAD FAULT ●
OUTPUT ARCING ●	FILAMENT POWER ●
HV OUT OF REGULATION ●	EXTERNAL CONTROL FAULT ●

Figure 5-9 Inverter Overload and Overtemperature LEDs

Inverter Overload LED

- LED turns red if inverter current reaches the maximum allowable value of 100 A

Overtemperature LED

- LED turns red: (a) when temp. of inverter or internal heat exchanger is $\geq 67^\circ\text{C}$, or (b) when cooling fan tachometer detects improper rotation speed

HV OFF ●	HV ON ●
POWER ON ●	INTERLOCKS OK ●
POWER SUPPLY FAULT ●	ARC / OUT OF REGULATION ●
RAIL UNDERVOLTAGE ●	INVERTER OVERLOAD ●
HV OVERCURRENT ●	OVERTEMPERATURE ●
HV OVERVOLTAGE ●	AUX SUPPLY LOW ●
SETPOINT OVERVOLTAGE ●	FILAMENT LOAD FAULT ●
OUTPUT ARCING ●	FILAMENT POWER ●
HV OUT OF REGULATION ●	EXTERNAL CONTROL FAULT ●

Figure 5-10 Aux Supply Low and External Control Fault LEDs

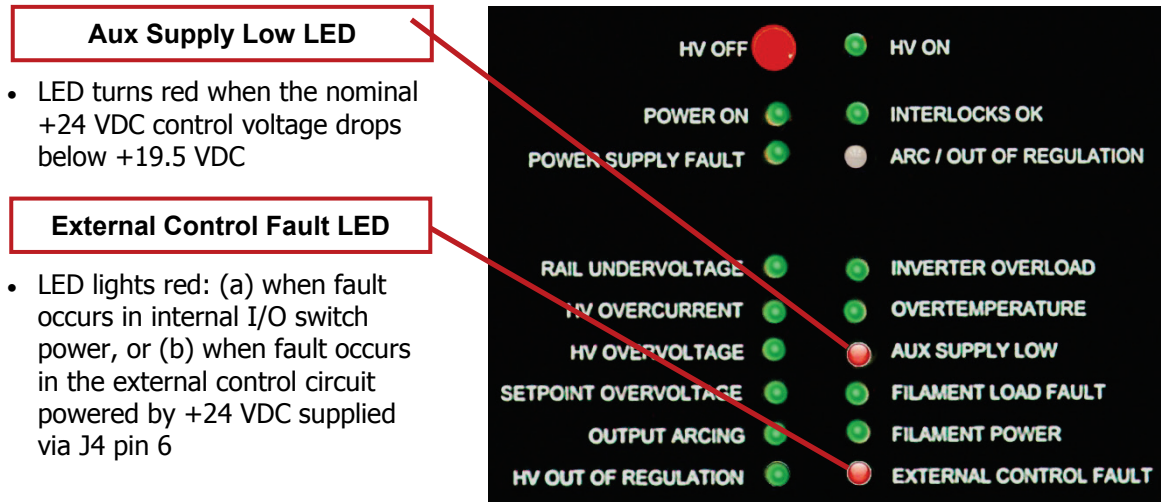

5.3 Ishikawa Diagrams

Each of the following diagrams illustrates the troubleshooting logic that applies in the case of a given fault condition. The diagrams, in order, are:

Ishikawa Diagram #1: No Input Power	7
Ishikawa Diagram #2: Interlock Fault	7
Ishikawa Diagram #3: No Beam After HV and Gun Are Switched ON	8
Ishikawa Diagram #4: HV Output Unstable	8
Ishikawa Diagram #5: <i>HV Out of Regulation</i> LED Lights Frequently	9
Ishikawa Diagram #6: <i>Arc/Out of Regulation</i> LED Lights Excessively for the Material/Application	9
Ishikawa Diagram #7: Rail Undervoltage Fault	10
Ishikawa Diagram #8: HV Overcurrent Fault.....	10
Ishikawa Diagram #9: HV Overvoltage Fault	11
Ishikawa Diagram #10: Setpoint Overvoltage Fault.....	11
Ishikawa Diagram #11: Output Arcing Fault	12
Ishikawa Diagram #12: Overtemperature Fault	12
Ishikawa Diagram #13: Aux Power Supply Low Fault	13
Ishikawa Diagram #14: External Control Fault.....	13
Ishikawa Diagram #15: Filament Load Fault.....	14
Ishikawa Diagram #16: Simultaneous Filament Load Fault + Filament Power Fault.....	14
Ishikawa Diagram #17: Emission Current Unstable	15

Ishikawa Diagram #1: No Input Power

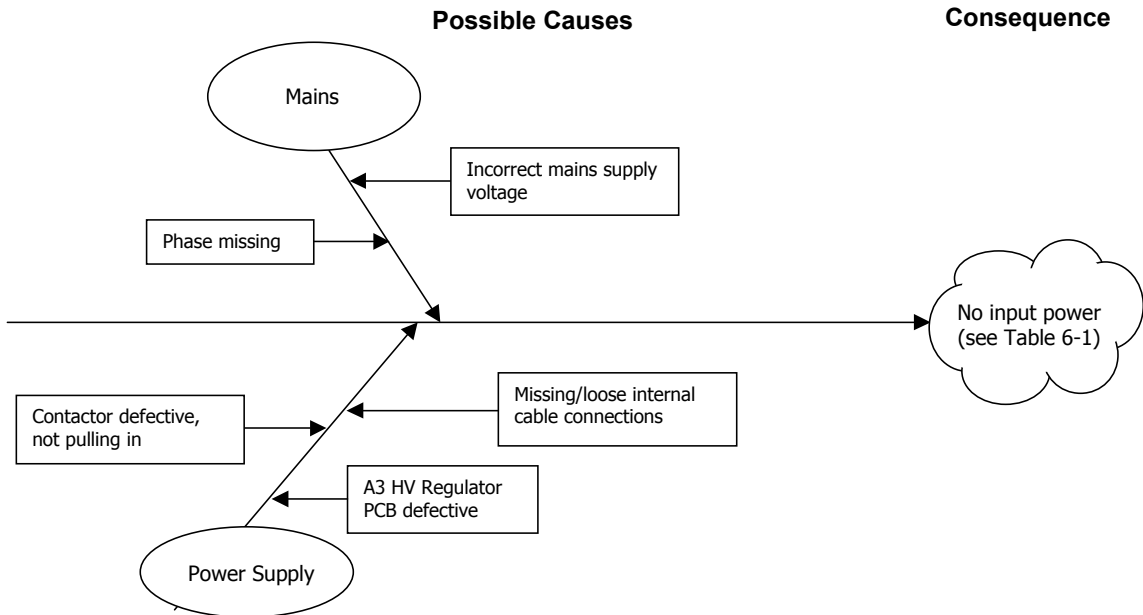

Ishikawa Diagram #2: Interlock Fault

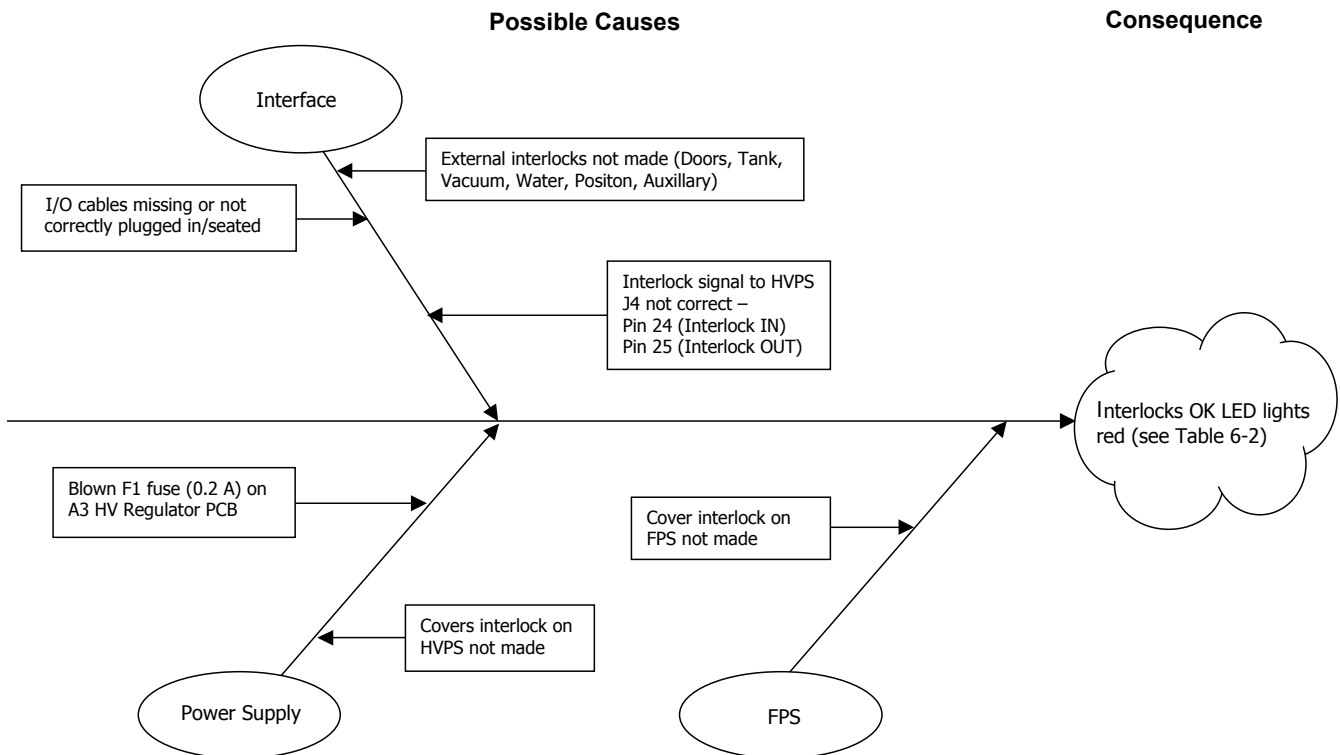

Ishikawa Diagram #3: No Beam After HV and Gun Are Switched ON

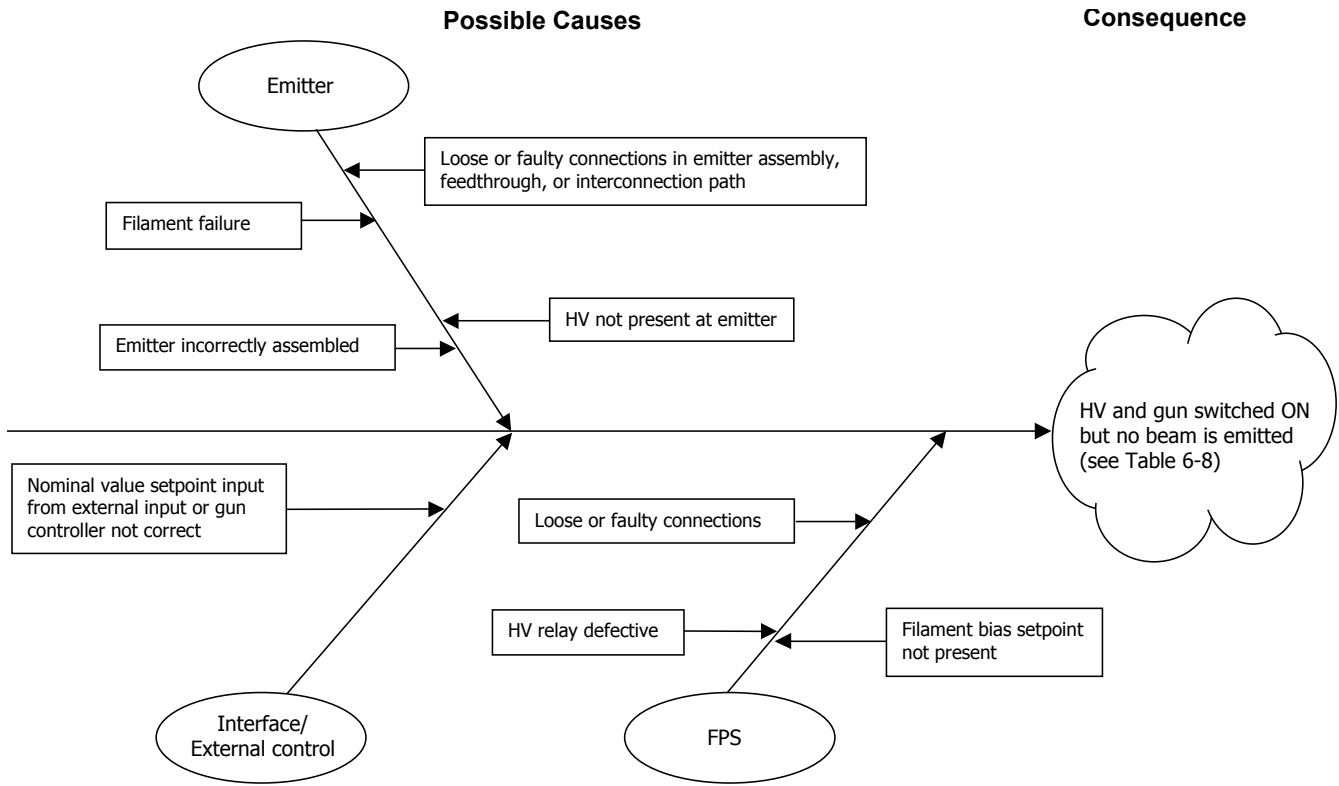

Ishikawa Diagram #4: HV Output Unstable

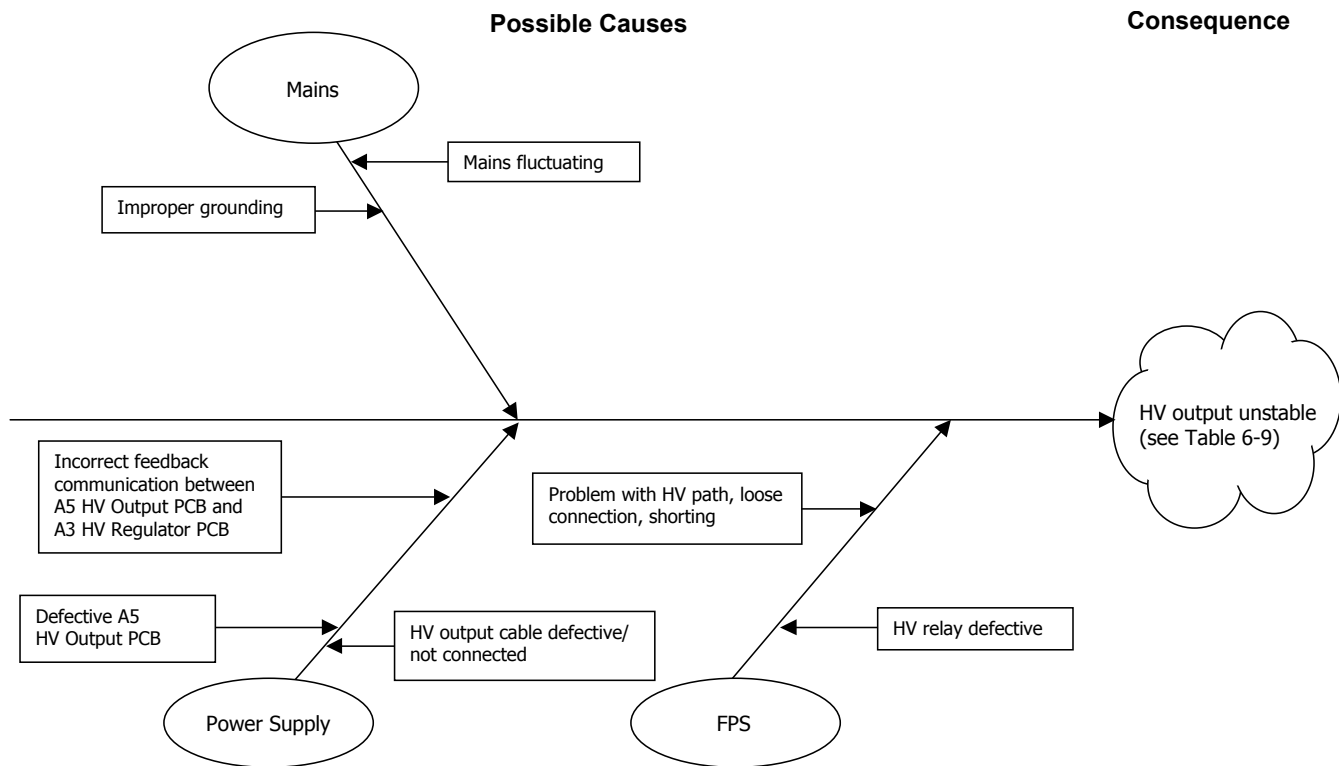

Ishikawa Diagram #5: HV Out of Regulation LED Lights Frequently

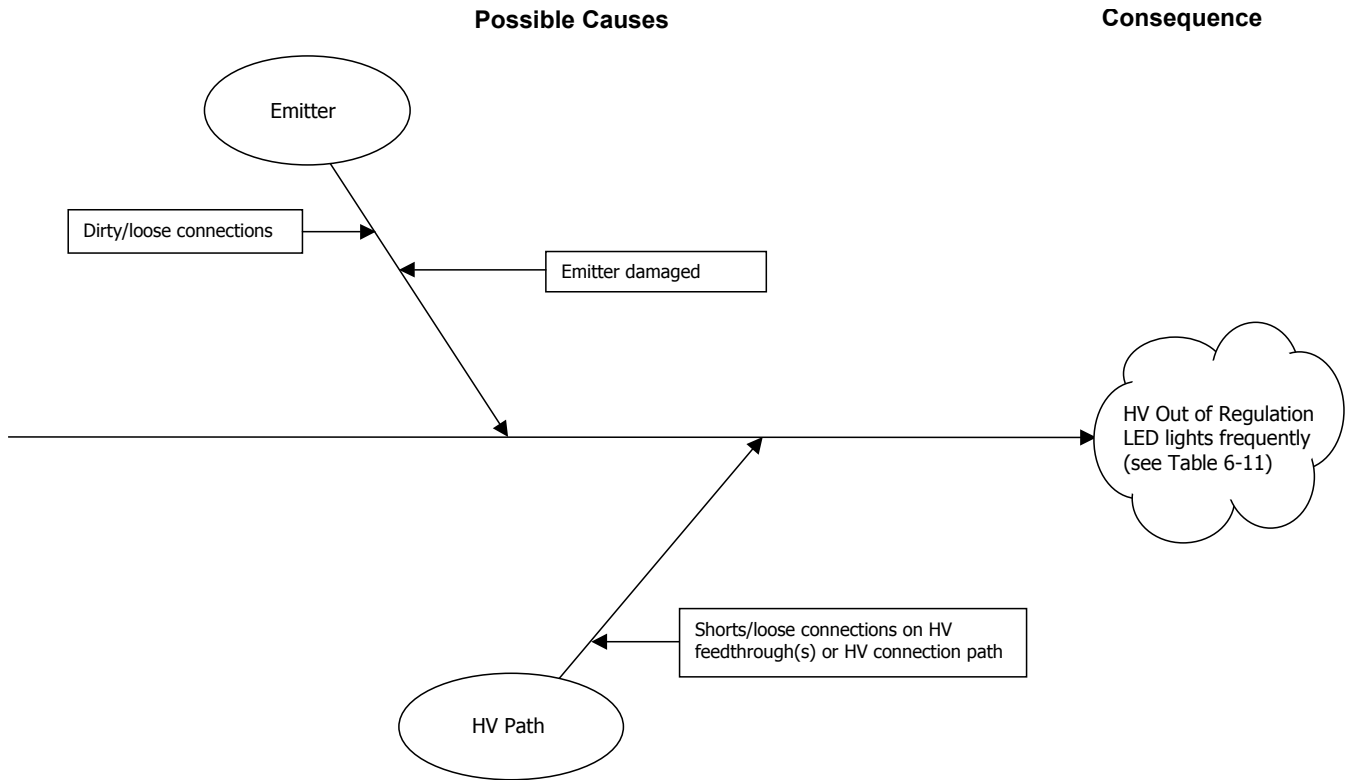

Ishikawa Diagram #6: Arc/Out of Regulation LED Lights Excessively for the Material/Application

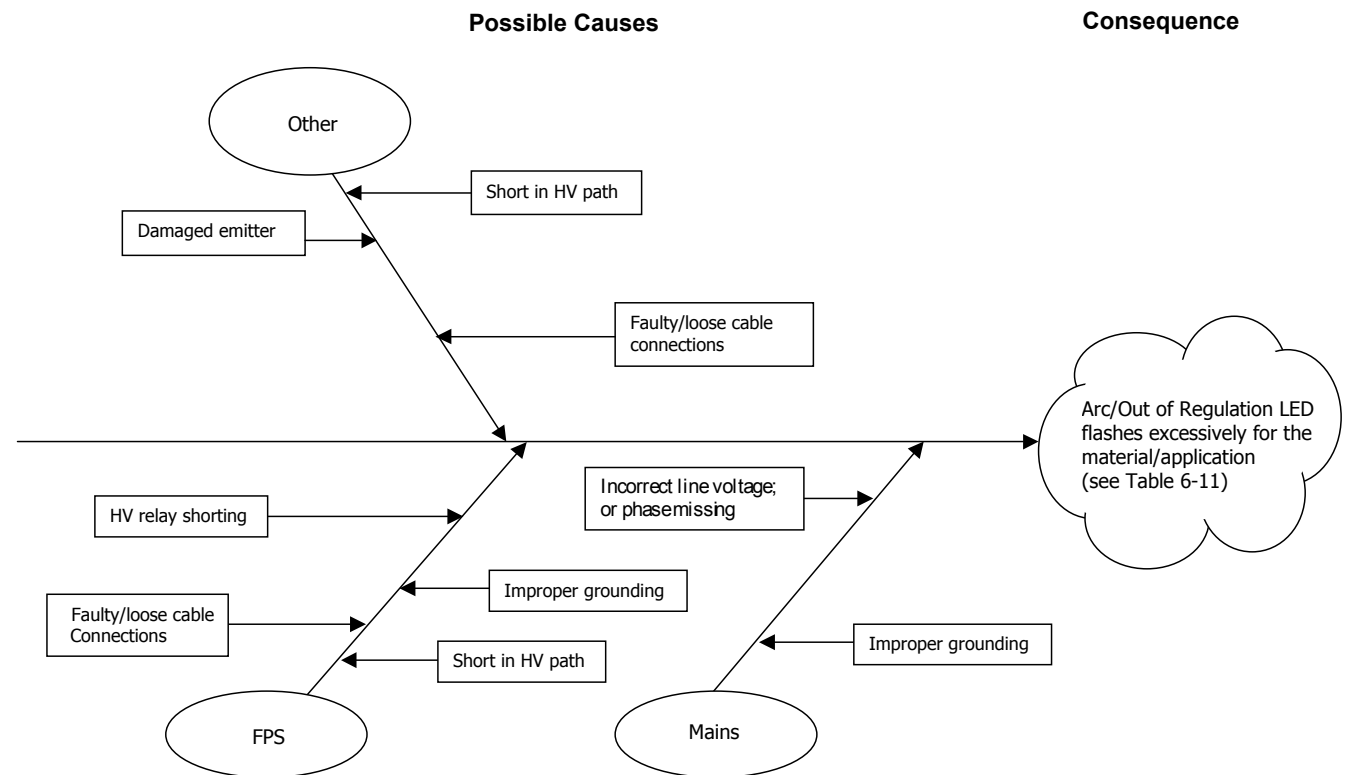

Ishikawa Diagram #7: Rail Undervoltage Fault

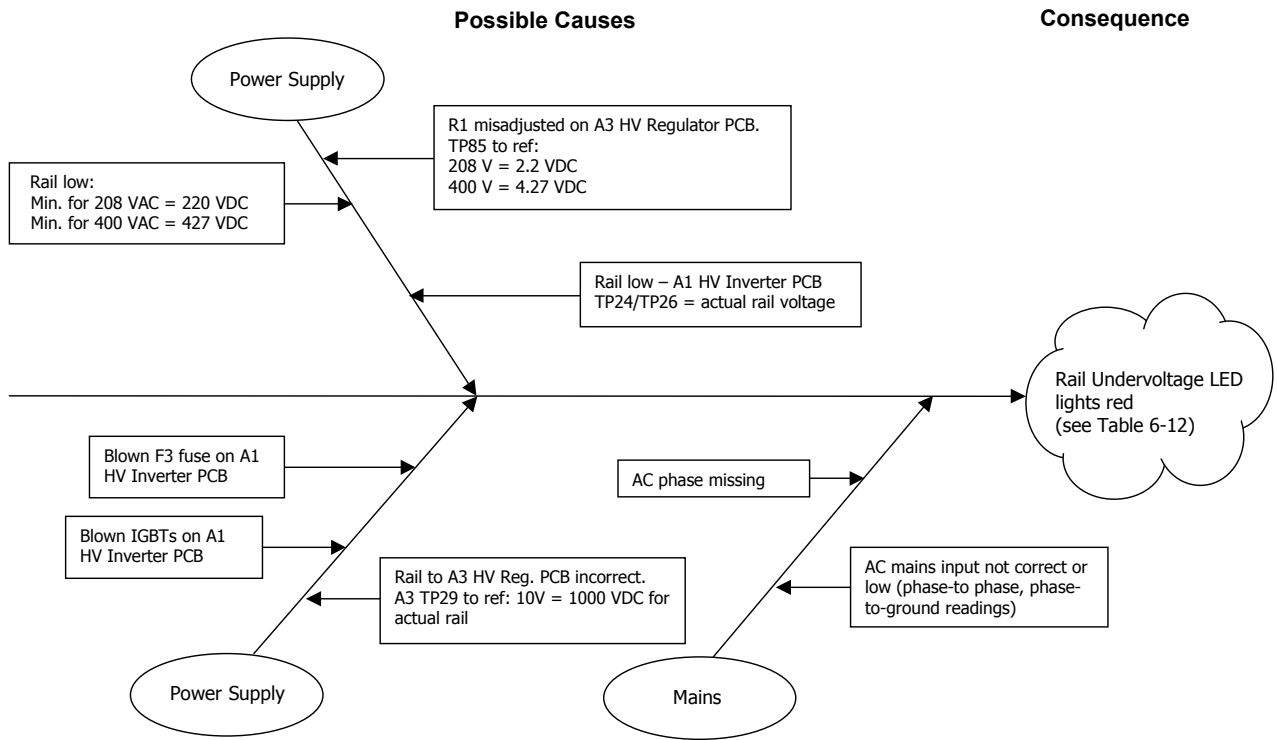

Ishikawa Diagram #8: HV Overcurrent Fault

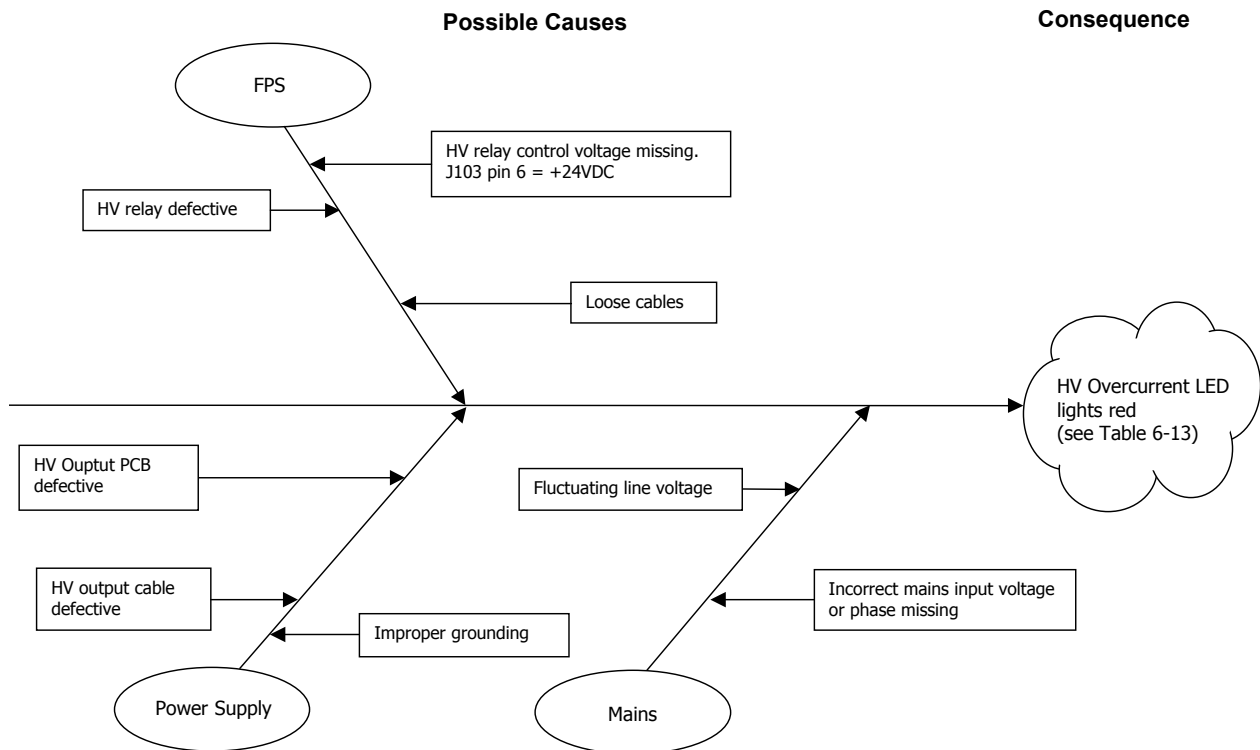

Ishikawa Diagram #9: HV Overvoltage Fault

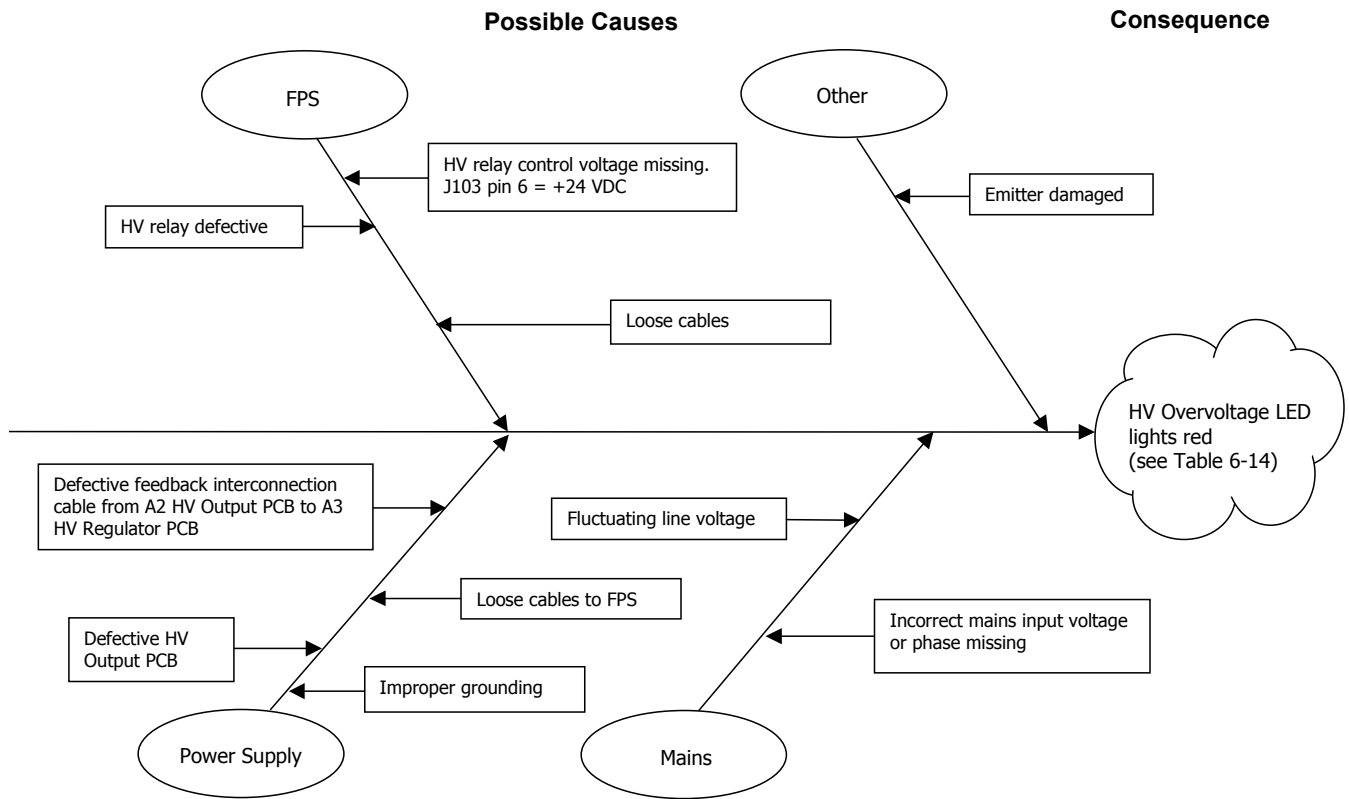

Ishikawa Diagram #10: Setpoint Overvoltage Fault

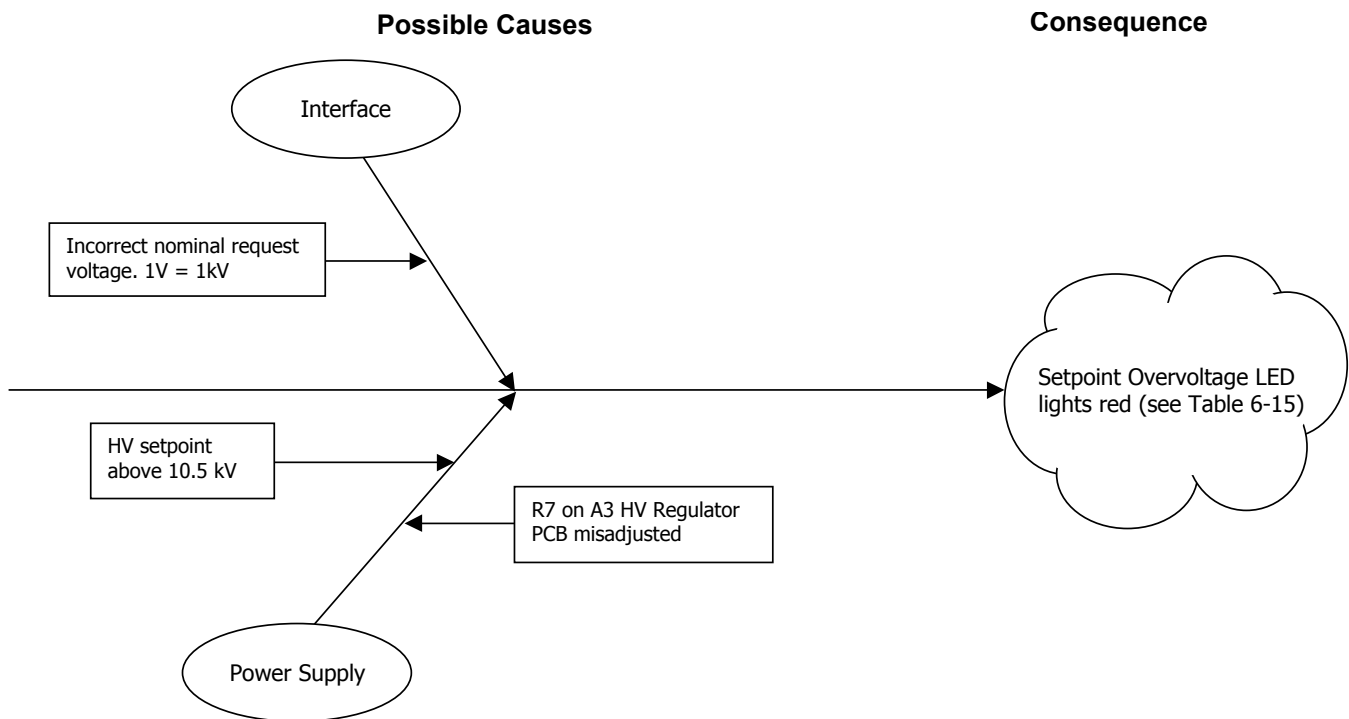

Ishikawa Diagram #11: Output Arcing Fault

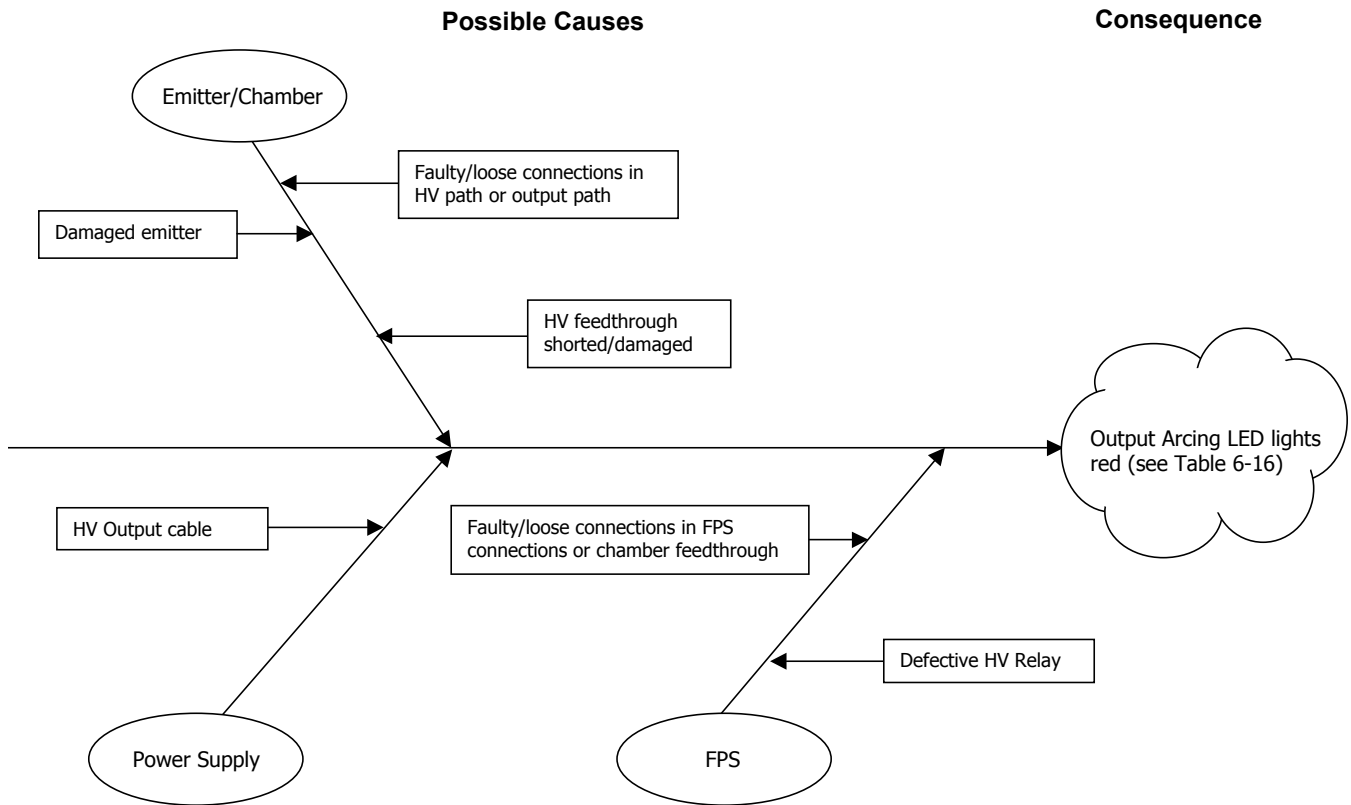

Ishikawa Diagram #12: Overtemperature Fault

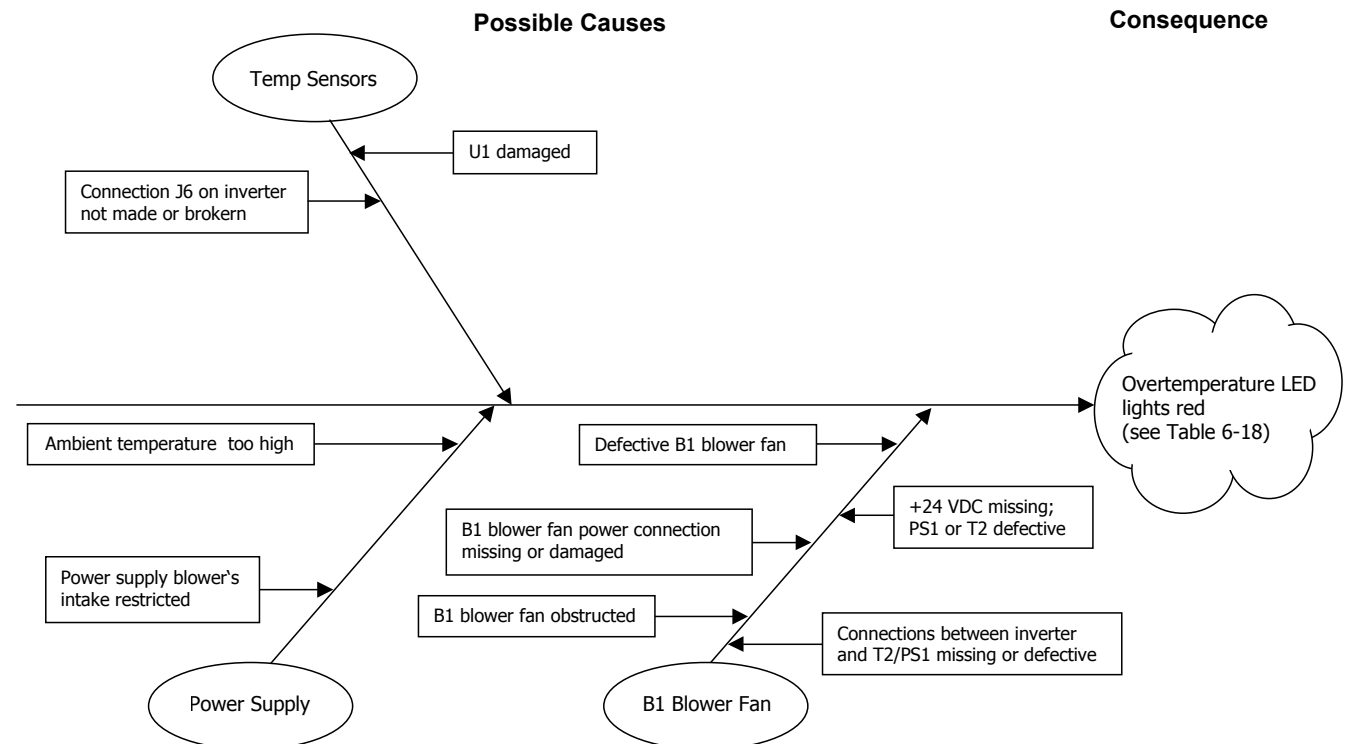

Ishikawa Diagram #13: Aux Power Supply Low Fault

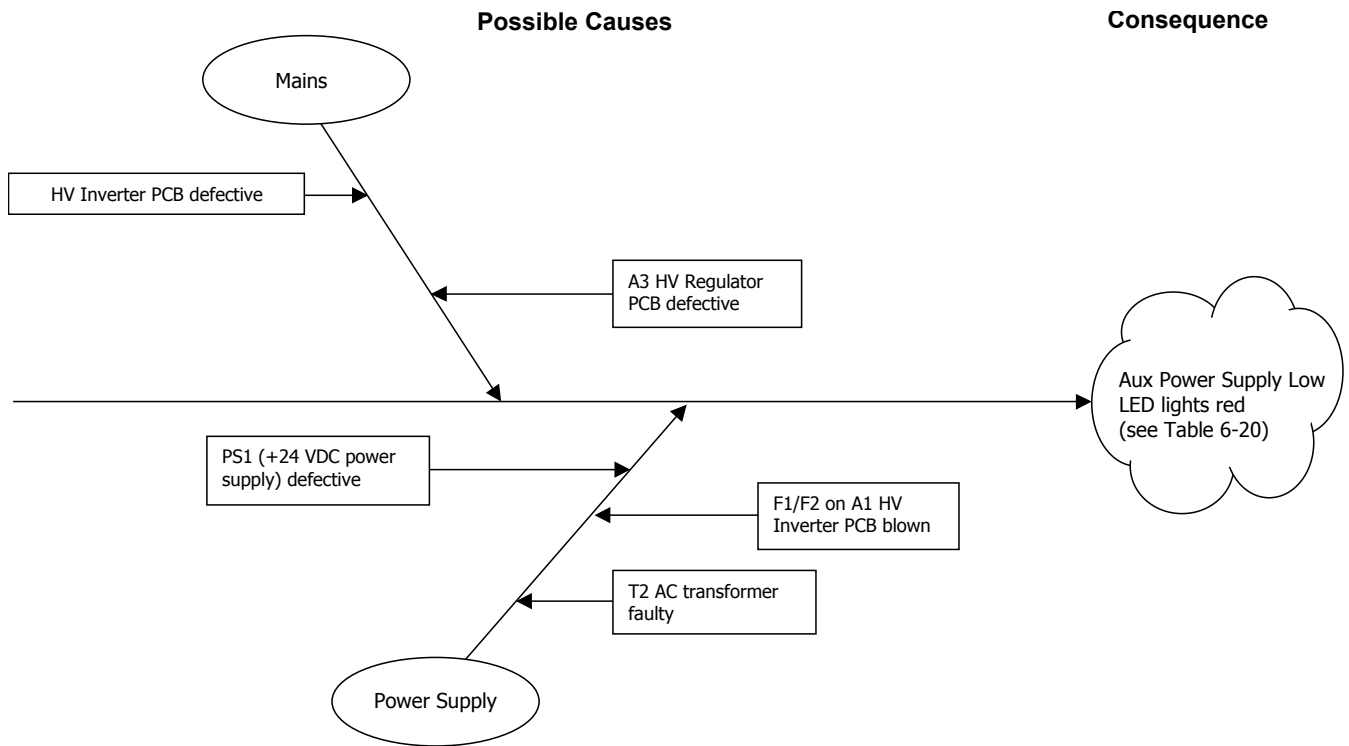

Ishikawa Diagram #14: External Control Fault

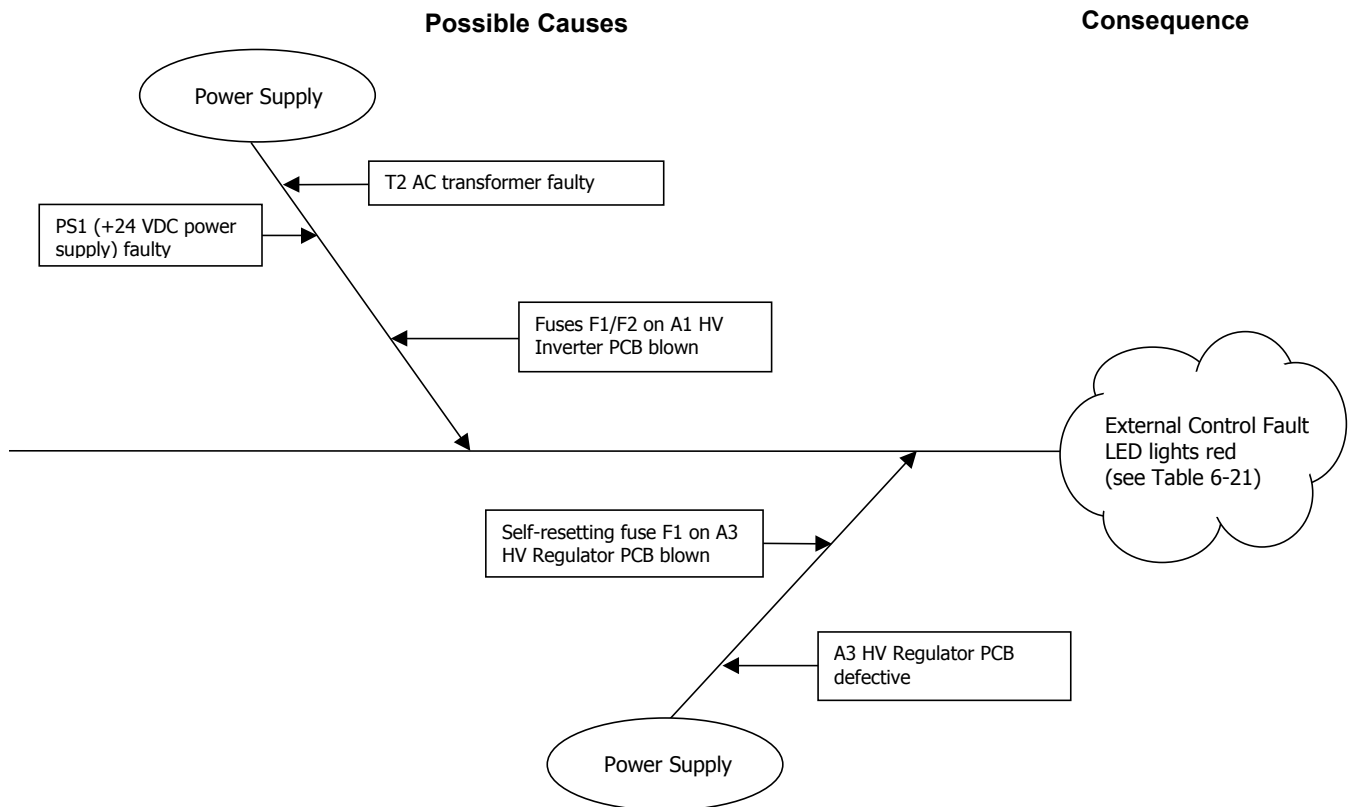

Ishikawa Diagram #15: Filament Load Fault

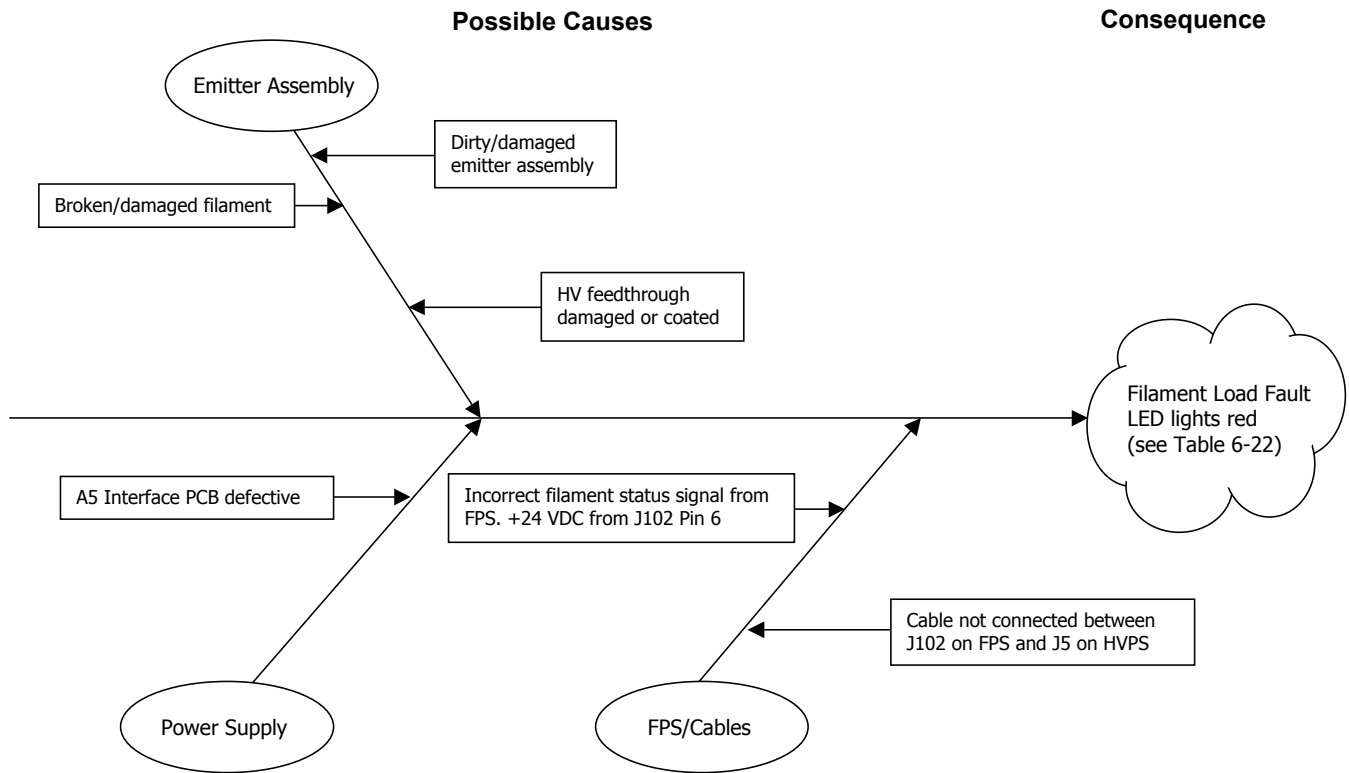

Ishikawa Diagram #16: Simultaneous Filament Load Fault + Filament Power Fault

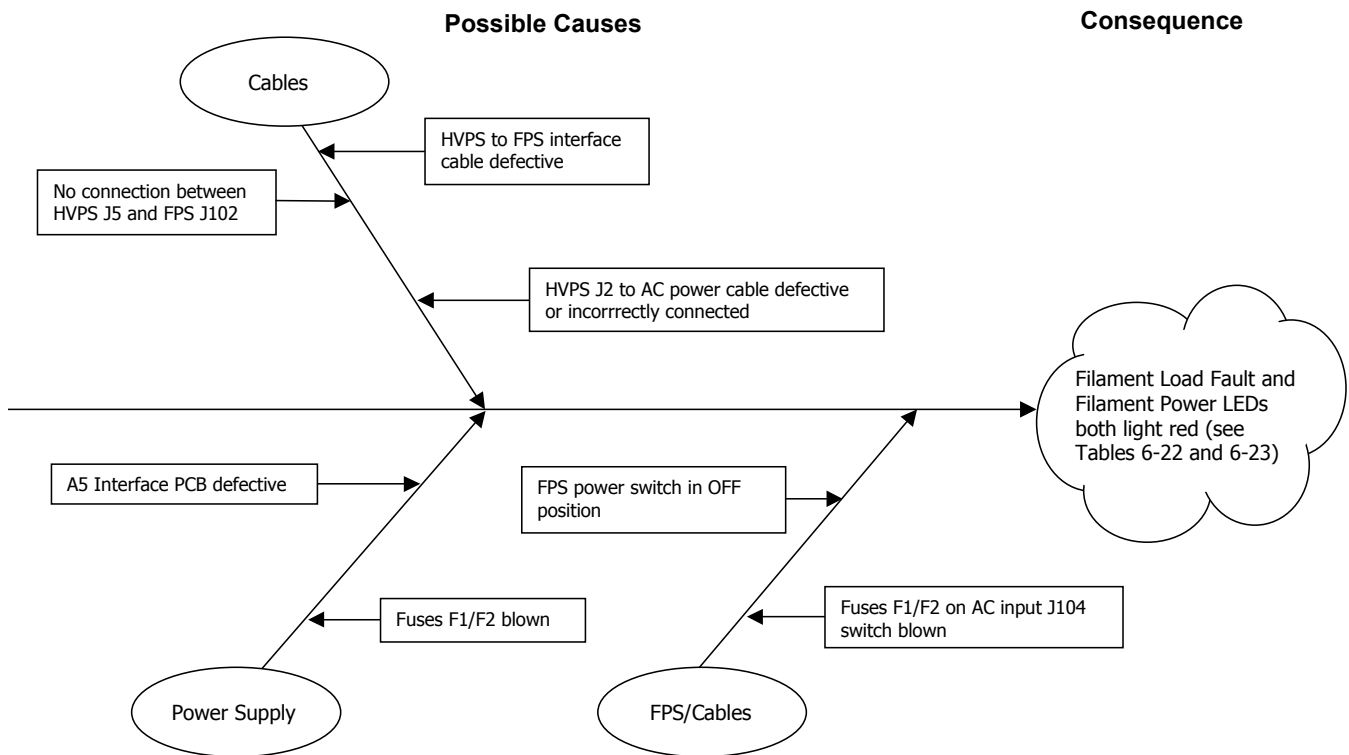

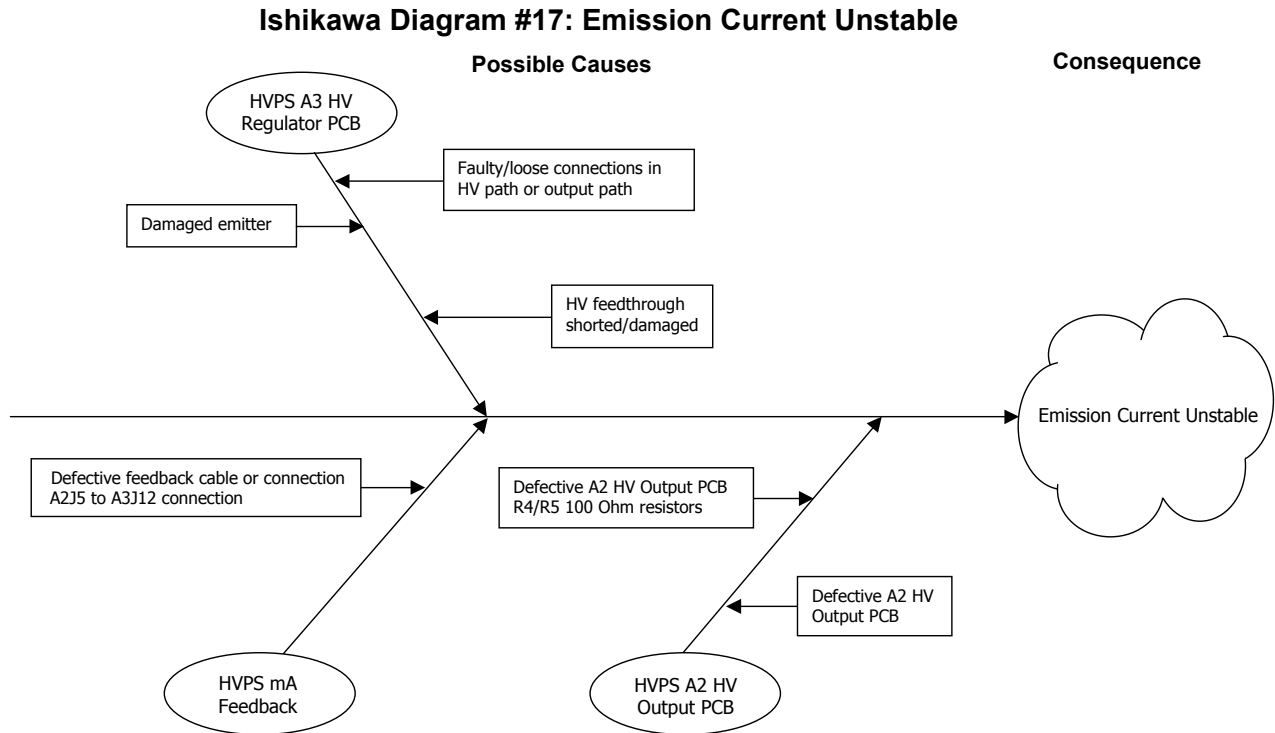

5.4 Troubleshooting Procedures

5.4.1 Checkout of HV Circuit and Cable Connections

Before performing procedures described in Tables 5-5, 5-6, and 5-8 through 5-21, perform the following procedure to verify the integrity of the HV circuit and the power supply's cable connections. Follow all safety procedures described in the e-beam gun manual.

Step	Action
1	Vent the vacuum system to atmosphere and lower the source tray.
2	Touch a properly installed grounding hook to the e-beam gun's emitter, to the HV feedthroughs, and to the source tray.
3	Check the emitter assembly, the HV leads, the HV feedthroughs, and the source tray for flakes and debris and clean as necessary.
4	Check the emitter's filament for breaks and replace if necessary.
5	Check the emitter assembly, the HV leads, the HV feedthroughs, and the atmosphere side HV cables for possible shorts. Correct any shorts found.
6	Check all cable interconnections between components of the power supply and between the power supply and the vacuum system. Verify that all connections are correctly and securely made.

5.4.2 Troubleshooting Tables

This section contains the following troubleshooting tables:

Table Number and Title

Table 5-1 No Input Power Indicated..... 5-16

Table 5-2 One or More Interlocks Not Made..... 5-17

Table 5-3 General Condition: HVPS Powered Up But Fails to Achieve HV Ready State..... 5-17

Table 5-4 HVPS and FPS Are Powered Up but GUN READY State Not Achieved/Confirmed 5-18

Table 5-5 HVPS Powered Up but HV Does Not Switch On When Commanded To Do So..... 5-18

Table 5-6 FPS Powered Up but Gun Does Not Switch On When Commanded To Do So..... 5-19

Table 5-7 No Filament Current After GUN ON State Is Achieved..... 5-19

Table 5-8 No Beam Emitted After HV and Gun Are Switched On 5-20

Table 5-9 HV Output Unstable 5-20

Table 5-10 Filament Current Out Of Regulation..... 5-21

Table 5-11 HVPS ARC/OUT OF REGULATION LED Flashes Excessively 5-21

Table 5-12 HVPS RAIL UNDERVOLTAGE LED Lights Red 5-22

Table 5-13 HVPS HV OVERCURRENT LED Lights Red..... 5-23

Table 5-14 HVPS HV OVERVOLTAGE LED Lights Red 5-24

Table 5-15 HVPS SETPOINT OVERVOLTAGE LED lights red..... 5-25

Table 5-16 HVPS OUTPUT ARCING LED lights red..... 5-25

Table 5-17 HVPS INVERTER OVERLOAD LED lights red 5-26

Table 5-18 HVPS OVERTEMPERATURE LED lights red..... 5-27

Table 5-19 Fan fails to rotate when HVPS is powered up 5-27

Table 5-20 HVPS AUXILIARY SUPPLY LOW LED lights red..... 5-28

Table 5-21 HVPS EXTERNAL CONTROL FAULT LED lights red..... 5-28

Table 5-22 HVPS FILAMENT LOAD FAULT LED lights red 5-28

Table 5-23 HV Is Switched On but FPS Front Panel HIGH VOLTAGE ON LED Fails To Light 5-29

Table 5-24 FPS #1 Is Switched On but Its POWER ON LED Fails To Light 5-29

Table 5-25 FPS #2 Is Switched On but Its POWER ON LED Fails To Light 5-29

Each table is organized around a set of operational symptoms that should be easily identifiable to the operator. For functional descriptions of the HVPS front panel LEDs, see section 5.2. For descriptions of the LEDs on the FPS, see section 3.3. The Ishikawa diagrams in section 5.3 provide additional information about the faults covered in many of the troubleshooting tables.

Table 5-1 No Input Power Indicated

Symptoms

- TCS displays **PSU1_RDY_ALM** (= Power Supply Control Not Ready Timeout Alarm).
- HVPS Front Panel: No LEDs are lit, and displays are dark.

For additional information about this fault mode, see Ishikawa Diagram #1.

Possible Causes	Procedure
1. Loss of main line power	1. Check to see whether input line voltages a HVPS rear panel terminals L1, L2, and L3 are within specifications for your facility. If so, proceed to next step. If not, check circuit protection devices (i.e., either circuit breakers or fuses) on the facility input power circuit to ensure they are not tripped or blown.
2. Power supply's front breakers are tripped.	2. Reset front breakers and attempt to power up the unit. If breakers trip again, proceed to next step.

3. Loose or faulty line power connection	3. Check for secure connections on main three-phase line power connector on rear of unit.
4. Fault condition(s) whose investigation requires removal of HVPS top cover.	4. Contact Temescal Field Service.

Table 5-2 One or More Interlocks Not Made

Symptoms

- TCS displays **PSU1_RDY_ALM** (= Power Supply Control Not Ready Timeout Alarm)
- HVPS Front Panel: **INTERLOCKS OK** and **POWER SUPPLY FAULT** LEDs light red
- EBC issues one of the following alarms: **Aux Connect Water Supply Interlock Alarm, Aux Connect Aux Interlock Alarm, Aux Connect Vacuum Interlock Alarm, Aux Connect Tank Interlock Alarm**. In addition, one of the LEDs in the High Voltage/Gun Interlocks section of the Diagnostics screen is unlit.

For additional information about this fault mode, see Ishikawa Diagram #2.

Possible Causes	Procedure
1. Interlock indicated by EBC is not made.	1. Troubleshoot the external indicated external interlock(s) (i.e., Tank (= vacuum cubicle doors), Vacuum, Auxiliary, Water, Position).
2. Top-cover interlock switch on either HVPS or FPS is not made.	2. First make sure that the top covers of the HVPS and the FPS are secured properly in place. If so, make sure that the HVPS-FPS cable (PN 0620-6672-0) is securely connected to HVPS rear-panel connector J5 and to FPS connector J102
3. Fault condition(s) whose investigation requires removal of HVPS top cover..	3. Contact Temescal Field Service.

Table 5-3 General Condition: HVPS Powered Up But Fails to Achieve HV Ready State

Symptoms

- TCS displays **PSU1_RDY_ALM** (= Power Supply Control Not Ready Timeout Alarm)
- EBC issues **HVPS Not Ready Timeout** alarm

Possible Causes	Procedure
1. On systems equipped with a Temescal PopTop e-beam gun, the crucible cover is not in the Down position.	1. Verify that cover is physically in the Down position and that the gun's Down position switch is correctly adjusted.
2. Confirm that the HVPS front-panel POWER ON LED is lit and that all HV and gun interlocks are made.	2. Check interlock string (see Table 5-2).
3. Faulty or loose connection(s) at one end of the HV Control-Vacuum System I/O cable (PN 0620-9840-0).	3. Verify that cable is securely connected to HVPS J4 and to connectors HVJ1 and HVJ2 on the remote controller rear panel.
4. An externally supplied HV READY signal is not high.	4. Troubleshoot the vacuum system end of the HV IS READY loop.
5. Fault condition(s) whose investigation requires removal of HVPS top cover..	5. Contact Temescal Field Service.

Table 5-4 HVPS and FPS Are Powered Up but GUN READY State Not Achieved/Confirmed

Symptoms

- TCS displays **SRC1_GON_ALM** (= Source 1 Gun Control GO ON Timeout Alarm)
- EBC issues **FPS Gun Ctl Go On Timeout** alarm

Possible Causes	Procedure
1. Confirm that all interlocks are made.	1. See Table 5-2.
2. Faulty or loose cable connections.	2. Make sure that all power module and FPS cable connections are correctly and securely made.
3. GUN ENABLE input at Pin 6 on FPS connector J101 is high.	3. Check input at Pin 6. If high, proceed to Step 4. If low, investigate the GUN ENABLE loop upstream of the FPS.
4. Fault condition(s) whose investigation requires removal of FPS top cover.	4. Contact Temescal Field Service.

DANGER: HIGH VOLTAGE
 Before performing the following procedure, perform the procedure described in section 5.4.3.

Table 5-5 HVPS Powered Up but HV Does Not Switch On When Commanded To Do So

Symptoms:

- TCS displays **PSU1_GON_ALM** (= Power Supply Control Go On Timeout Alarm)
- HVPS Front Panel: **HV ON** LED fails to light Green
- EBC issues **HVPS Go On Failure** alarm

Possible Causes	Procedure
1. HV READY signal is not present.	1. See Table 5-3.
2. After remote HV GO ON command is issued, HV ON signals are not supplied via Pins 8-9 of HVPS J4.	2. Verify that the remote HV GO ON signal is supplied by EBC or PLC-based system controller.

If the preceding steps have failed to correct the fault, perform the following procedure:

1. Switch off the power supply.
2. Disconnect HV output cable.
3. Switch on the power supply and the HV and leave them switched on for no more than 9 seconds, observing whether the symptom persists during that interval.

CAUTION
 DO NOT leave the high voltage on for more than 9 seconds with the HV cable disconnected. Doing so will result in the emitter's filament burning out.

4. If the symptom is not in evidence during Step 3, troubleshoot the HV path and emitter assembly, following the instructions in the e-gun manual. If the symptom persists during Step 3, reconnect the HV output cable to J101, switch the power supply back on, and proceed with the troubleshooting steps described below.

3. Fault condition(s) whose investigation requires removal of HVPS top cover.	3. Contact Temescal Field Service.
---	------------------------------------

DANGER: HIGH VOLTAGE
 Before performing any of the procedures described on this page, perform the procedure described in section 5.4.1.

Table 5-6 FPS Powered Up but Gun Does Not Switch On When Commanded To Do So

Symptoms

- TCS displays **SRC1_GON_ALM** (= Source 1 Control Go On Timeout Alarm)
- Remote Controller: Gun Ready light inside Gun Control panel’s OFF button fails to light
- EBC issues **FPS Gun Ctl Go On Timeout** alarm

Possible Causes	Procedure
1. Faulty or loose cable connections.	1. Make sure that all power module and FPS cable connections are correctly and securely made.
2. Confirm Gun Ready signal	2. See Table 5-4.
3. Emitter damaged	3. Follow instructions in gun manual to troubleshoot emitter issues.

If the preceding steps have failed to correct the fault, perform the following procedure:

1. Switch off the power supply.
2. Disconnect HV output cable.
3. Switch on the power supply and the HV and leave them switched on for no more than 9 seconds, observing whether the symptom persists during that interval.

CAUTION
 DO NOT leave the high voltage on for more than 9 seconds with the HV cable disconnected. Doing so will result in the emitter’s filament burning out.

4. If the symptom is not in evidence during Step 3, troubleshoot the HV path and emitter assembly, following the instructions in the e-gun manual. If the symptom persists during Step 3, reconnect the HV output cable to J101, switch the power supply back on, and proceed with the troubleshooting steps described below.

4. Fault conditions whose investigation requires removal of FPS top cover.	4. Contact Temescal Field Service.
--	------------------------------------

Table 5-7 No Filament Current After GUN ON State Is Achieved

Symptom: Gun switches on but has no filament current

Possible Causes	Procedure
1. Faulty or loose cable connections.	1. Make sure that all power module and FPS cable connections are correctly and securely made.
2. Emitter damaged	2. Follow instructions in gun manual to troubleshoot emitter issues.
3. Incorrect filament bias current	3. Adjust filament bias current
4. FPS fault	4. See Tables 5-23, 5-24, and 5-25.
5. Fault conditions whose investigation requires removal of FPS top cover.	5. Contact Temescal Field Service.

DANGER: HIGH VOLTAGE
 Before performing any of the procedures described on this page, perform the procedure described in section 5.4.1.

Table 5-8 No Beam Emitted After HV and Gun Are Switched On

Symptom: HV and gun are switched on, but no beam is emitted

For additional information about this fault mode, see Ishikawa Diagram #3.

Possible Causes	Procedure
1. Faulty or loose connections.	1. Make sure that all HV and FPS connections are correctly and securely made.
2. Confirm HV Ready signal	2. See Table 5-3.
3. Confirm Gun Ready signal	3. See Table 5-4.
4. Emitter damaged	4. Follow instructions in gun manual to troubleshoot emitter issues.
5. Confirm HV IS ON signal	5. See Table 5-5.
6. Confirm GUN IS ON signal	6. See Table 5-6.
7. Fault conditions whose investigation requires removal of FPS top cover.	7. Contact Temescal Field Service.

DANGER: HIGH VOLTAGE
 Before performing the following procedure, perform the procedure described in section 5.4.3.

Table 5-9 HV Output Unstable

Symptom: HV fluctuates or sags from requested level

For additional information about this fault mode, see Ishikawa Diagram #4.

Possible Causes	Procedure
1. Incorrect or fluctuating line voltage	1. Confirm input line voltage
2. Faulty or loose cable connections.	2. Make sure that all power module and FPS cable connections are correctly and securely made.
3. Emitter damaged	3. Follow instructions in gun manual to troubleshoot emitter issues.
4. System incorrectly grounded for HV	4. Make sure that grounding instructions in e-gun manual have been correctly implemented.

If the preceding steps have failed to correct the fault, perform the following procedure:

1. Switch off the power supply.
2. Disconnect HV output cable.
3. Switch on the power supply and the HV and leave them switched on for no more than 9 seconds, observing whether the symptom persists during that interval.

CAUTION
 DO NOT leave the high voltage on for more than 9 seconds with the HV cable disconnected. Doing so will result in the emitter's filament burning out.

4. If the symptom is not in evidence during Step 3, troubleshoot the HV path and emitter assembly, following the instructions in the e-gun manual. If the symptom persists during Step 3, reconnect the HV output cable to J101, switch the power supply back on, and proceed with the troubleshooting steps described below.

5. Fault conditions whose investigation requires removal of HVPS top cover.	5. Contact Temescal Field Service.
---	------------------------------------

DANGER: HIGH VOLTAGE
 Before performing any of the procedures described on this page, perform the procedure described in section 5.4.1.

Table 5-10 Filament Current Out Of Regulation

Symptom: When gun and HV are switched on, filament current ramps up and goes out of regulation

Possible Causes	Procedure
1. Faulty or loose connections.	1. Make sure that all HV and FPS connections are correctly and securely made.
2. Short in HV path	2. Check emitter, feethroughs, and cables for signs of shorts.
3. Emitter damaged	3. Follow instructions in gun manual to troubleshoot emitter issues.
4. Fault conditions whose investigation requires removal of FPS top cover.	4. Contact Temescal Field Service.

Table 5-11 HVPS ARC/OUT OF REGULATION LED Flashes Excessively

Condition indicated: Subthreshold arcing is occurring and/or HV is intermittently out of regulation

NOTE: A problem exists only if arcing is excessive for the material or process in question

Symptoms:

- HVPS front panel: The **ARC/OUT OF REGULATION** LED flashes excessively. The **HV OUT OF REGULATION** LED turns yellow for 2 seconds each time the **ARC/OUT OF REGULATION** LED flashes

For additional information about this fault mode, see Ishikawa Diagram #6 in Appendix A.

Possible Cause	Procedure
1. Emitter damaged	1. Follow instructions in gun manual to troubleshoot emitter issues.
2. Faulty or loose connections.	2. Make sure that all HV and FPS connections are correctly and securely made.
3. HV feedthrough shorted	3. Check copper bus bars and HV feedthroughs for shorts, coatings, cracks or arc marks
4. Chamber Pressure too high	4. Chamber pressure should be less than 1×10^{-5} mTorr.
5. System improperly grounded for HV.	5. Follow grounding instructions provided in e-gun manual.
6. Incorrect or fluctuating line voltage	6. Confirm input line voltage
7. Fault conditions whose investigation requires removal of HVPS top cover.	7. Contact Temescal Field Service.

DANGER: HIGH VOLTAGE
 Before performing the following procedure, perform the procedure described in section 5.4.1.

Table 5-12 HVPS RAIL UNDERVOLTAGE LED Lights Red

Condition indicated: Rail voltage below 220 V dc (on 208-V units) or 427 V dc (on 400-V units)

NOTE: Nominal rail voltage ranges are 264-323 V dc (for 208-V units) and 509-622 V dc (for 400-V units)

Symptoms:

- TCS displays **PSU1_FAIL_ALM** (= Power Supply Control Is On failure alarm)
- HVPS Front Panel: **RAIL UNDER VOLTAGE** and **POWER SUPPLY FAULT** LEDs are lit
- EBC: **Fault** LED lit in High Voltage section of Diagnostics screen

For additional information about this fault mode, see Ishikawa Diagram #7.

Possible Cause	Procedure
1. System improperly grounded for HV.	1. Follow grounding instructions provided in e-gun manual.
2. Incorrect line voltage.	2. Confirm line voltage as per manual.
3. Incorrect line phase.	3. Confirm line phase as per specifications.
4. Faulty or loose cable connections.	4. Make sure that all power module and FPS cable connections are correctly and securely made.

If preceding steps have failed to correct the fault, perform the following procedure:

1. Switch off the power supply.
2. Disconnect HV output cable from HVPS J1.
3. Switch on the power supply and the HV and leave them switched on for no more than 9 seconds, observing whether the symptom persists during that interval.

CAUTION
 DO NOT leave the high voltage on for more than 9 seconds with the HV cable disconnected. Doing so will result in the emitter's filament burning out.

4. If the symptom is not in evidence during Step 3, troubleshoot the emitter assembly, following the instructions in the e-gun manual. If the symptom persists during Step 3, reconnect the HV output cable to HVPS J1, switch the power supply back on, and proceed with the troubleshooting steps described below.

Possible Cause	Procedure
5. Fault conditions whose investigation requires removal of HVPS top cover.	5. Contact Temescal Field Service.

DANGER: HIGH VOLTAGE
 Before performing the following procedure, perform the procedure described in section 5.4.1.

Table 5-13 HVPS HV OVERCURRENT LED Lights Red

Condition indicated: HV Output current is above 636 mA

Symptoms

- TCS displays **PSU1_FAIL_ALM** (= Power Supply Control Is On failure alarm)
- HVPS Front Panel: **HV OVERCURRENT** and **POWER SUPPLY FAULT** LEDs are lit
- EBC: **Fault** LED lit in High Voltage section of Diagnostics screen

For additional information about this fault mode, see Ishikawa Diagram #8.

Possible Cause	Procedure
1. Incorrect or fluctuating line voltage	1. Confirm input line voltage
2. Faulty or loose cable connections.	2. Make sure that all power module and FPS cable connections are correctly and securely made.
3. Emitter damaged	3. Follow instructions in gun manual to troubleshoot emitter issues.
4. System improperly grounded for HV	4. Make sure that grounding instructions in e-gun manual have been correctly implemented.

If preceding steps have failed to correct the fault, perform the following procedure:

1. Switch off the power supply.
2. Disconnect HV output cable from HVPS J1.
3. Switch on the power supply and the HV and leave them switched on for no more than 9 seconds, observing whether the symptom persists during that interval.

CAUTION
 DO NOT leave the high voltage on for more than 9 seconds with the HV cable disconnected. Doing so will result in the emitter’s filament burning out.

4. If the symptom is not in evidence during Step 3, troubleshoot the emitter assembly, following the instructions in the e-gun manual. If the symptom persists during Step 3, reconnect the HV output cable to HVPS J1, switch the power supply back on, and proceed with the troubleshooting steps described below.

Possible Cause	Procedure
5. Fault conditions whose investigation requires removal of HVPS top cover.	5. Contact Temescal Field Service.

DANGER: HIGH VOLTAGE

Before performing the following procedure, perform the procedure described in section 5.4.1.

Table 5-14 HVPS HV OVERVOLTAGE LED Lights Red

Condition indicated: HV Output Voltage Is Above Maximum (i.e., 105% of Setpoint)

Symptoms

- TCS displays **PSU1_FAIL_ALM** (= Power Supply Control Is On failure alarm)
- HVPS Front Panel: **HV OVERVOLTAGE** and **POWER SUPPLY FAULT** LEDs are lit
- EBC: **Fault** LED lit in High Voltage section of Diagnostics screen

For additional information about this fault mode, see Ishikawa Diagram #9.

Possible Cause	Procedure
1. Incorrect or fluctuating line voltage	1. Confirm input line voltage
2. Faulty or loose cable connections.	2. Make sure that all power module and FPS cable connections are correctly and securely made.
3. Emitter damaged	3. Follow instructions in gun manual to troubleshoot emitter issues.
4. System improperly grounded for HV.	4. Make sure that grounding instructions in e-gun manual have been correctly implemented.

If preceding steps have failed to correct the fault, perform the following procedure:

1. Switch off the power supply.
2. Disconnect HV output cable from HVPS J1.
3. Switch on the power supply and the HV and leave them switched on for no more than 9 seconds, observing whether the symptom persists during that interval.

CAUTION

DO NOT leave the high voltage on for more than 9 seconds with the HV cable disconnected. Doing so will result in the emitter's filament burning out.

4. If the symptom is not in evidence during Step 3, troubleshoot the emitter assembly, following the instructions in the e-gun manual. If the symptom persists during Step 3, reconnect the HV output cable to HVPS J1, switch the power supply back on, and proceed with the troubleshooting steps described below.

Possible Cause	Procedure
5. Fault condition(s) whose investigation requires removal of HVPS top cover.	5. Contact Temescal Field Service.

DANGER: HIGH VOLTAGE

Before performing the following procedure, perform the procedure described in section 5.4.1.

Table 5-15 HVPS SETPOINT OVERVOLTAGE LED lights red

Condition indicated: HV output voltage is above 10.5 kV when setpoint is 10 kV

Symptoms

- TCS displays **PSU1_FAIL_ALM** (= Power Supply Control Is On failure alarm)
- HVPS Front Panel: **SETPOINT OVERVOLTAGE** and **POWER SUPPLY FAULT** LEDs are lit
- EBC: **Fault** LED lit in High Voltage section of Diagnostics screen

For additional information about this fault mode, see Ishikawa Diagram #10 in Appendix A.

Possible Cause	Procedure
1. Fault condition(s) whose investigation requires removal of HVPS top cover	1. Contact Temescal Field Service.

Table 5-16 HVPS OUTPUT ARCING LED lights red

Condition indicated: Latched PS fault due to either an arc duration > 120 ms or arc rate > 200 Hz

Symptoms

- TCS issues **PSU1_FAIL_ALM** (= Power Supply Control Is On failure alarm)
- HVPS Front Panel: **OUTPUT ARCING** and **POWER SUPPLY FAULT** LEDs are lit
- EBC: **Fault** LED lit in High Voltage section of Diagnostics screen

For additional information about this fault mode, see Ishikawa Diagram #11.

Possible Cause	Procedure
1. Faulty or loose connections.	1. Make sure that all HV and FPS connections are correctly and securely made.
2. Emitter damaged	2. Follow instructions in gun manual to troubleshoot emitter issues.
3. System improperly grounded for HV.	3. Make sure that grounding instructions in e-gun manual have been correctly implemented.
4. Chamber Pressure too high	4. Chamber pressure should be less than 1×10^{-5} mTorr.
5. HV feedthrough shorted	5. Check copper bus bars and HV feedthroughs for shorts, coatings, cracks or arc marks.
6. Fault condition(s) whose investigation requires checking HV output at FPS.	6. Contact Temescal Field Service.

DANGER: HIGH VOLTAGE
 Before performing the following procedure, perform the procedure described in section 5.4.1.

Table 5-17 HVPS INVERTER OVERLOAD LED lights red

Condition indicated: Inverter current > 150 A

Symptoms

- TCS displays **PSU1_FAIL_ALM** (= Power Supply Control Is On failure alarm)
- HVPS Front Panel: **INVERTER OVERLOAD** and **POWER SUPPLY FAULT** LEDs are lit
- EBC: **Fault** LED lit in High Voltage section of Diagnostics screen

Possible Cause	Procedure
1. Incorrect or fluctuating line voltage	1. Confirm input line voltage
2. Faulty or loose connections.	2. Make sure that all HV and FPS connections are correctly and securely made.

If preceding steps have failed to correct the fault, perform the following procedure:

1. Switch off the power supply.
2. Disconnect HV output cable from HVPS J1.
3. Switch on the power supply and the HV and leave them switched on for no more than 9 seconds, observing whether the symptom persists during that interval.

CAUTION
 DO NOT leave the high voltage on for more than 9 seconds with the HV cable disconnected. Doing so will result in the emitter's filament burning out.

4. If the symptom is not in evidence during Step 3, troubleshoot the emitter assembly, following the instructions in the e-gun manual. If the symptom persists during Step 3, reconnect the HV output cable to HVPS J1, switch the power supply back on, and proceed with the troubleshooting steps described below.

Possible Cause	Procedure
3. Rail voltage incorrect	3. See Table 5-12.
4. Fault condition(s) whose investigation requires removal of HVPS top cover	4. Contact Temescal Field Service.

DANGER: HIGH VOLTAGE

Before performing the following procedure, perform the procedure described in section 5.4.1.

Table 5-18 HVPS OVERTEMPERATURE LED lights red

Conditions indicated: One or more of the following: IGBT temp > 678 C, heat sink Temp >778 C, fan stopped, fan rotating too slowly

Symptoms

- TCS displays **PSU1_FAIL_ALM** (= Power Supply Control Is On failure alarm)
- HVPS Front Panel: **OVERTEMPERATURE** and **POWER SUPPLY FAULT** LEDs are lit
- EBC: **Fault** LED lit in High Voltage section of Diagnostics screen

For additional information about this fault mode, see Ishikawa Diagram #12 in Appendix A.

Possible Cause	Procedure
1. Incorrect or fluctuating line voltage	1. Check input line voltage.
2. Fault condition(s) whose investigation requires removal of HVPS top cover	2. Contact Temescal Field Service.

DANGER: HIGH VOLTAGE

Before performing the following procedure, perform the procedure described in section 5.4.3.

Table 5-19 Fan fails to rotate when HVPS is powered up

Symptoms

- TCS displays **PSU1_FAIL_ALM** (= Power Supply Control Is On failure alarm)
- HVPS Front Panel: **OVERTEMPERATURE** and **POWER SUPPLY FAULT** LEDs light red
- EBC: **Fault** LED lit in High Voltage section of Diagnostics screen

Possible Causes	Procedure
1. Fan is mechanically stuck	1. Check to see whether fan is clogged with dust or dirt. Excessive dust build-up around edges of fan will prevent it from moving. Clean and blow out dust. Restart power supply.
2. Fault condition(s) whose investigation requires removal of HVPS top cover	2. Contact Temescal Field Service.

Table 5-20 HVPS AUXILIARY SUPPLY LOW LED lights red

Condition indicated: Control Supply voltage is below minimum value

Symptoms

- TCS displays **PSU1_FAIL_ALM** (= Power Supply Control Is On failure alarm)
- HVPS Front Panel: **AUXILIARY SUPPLY LOW** and **POWER SUPPLY FAULT** LEDs light red
- EBC: **Fault** LED lit in High Voltage section of Diagnostics screen

For additional information about this fault mode, see Ishikawa Diagram #13.

Possible Cause	Procedure
1. Fault condition(s) whose investigation requires removal of HVPS top cover	1. Contact Temescal Field Service.

DANGER: HIGH VOLTAGE
 Before performing the following procedure, perform the procedure described in section 5.4.1.

Table 5-21 HVPS EXTERNAL CONTROL FAULT LED lights red

Condition indicated: I/O SWITCH POWER output (+24 V dc) supplied via Pin 6 on HVPS J4 is below its minimum value (< 20 V dc)

Symptoms

- TCS displays **PSU1_FAIL_ALM** (= Power Supply Control Is On failure alarm)
- HVPS Front Panel: **EXTERNAL CONTROL FAULT** and **POWER SUPPLY FAULT** LEDs are lit
- EBC: **Fault** LED lit in High Voltage section of Diagnostics screen

For additional information about this fault mode, see Ishikawa Diagram #14.

Possible Cause	Procedure
1. Fault condition(s) whose investigation requires removal of HVPS top cover	1. Contact Temescal Field Service.

Table 5-22 HVPS FILAMENT LOAD FAULT LED lights red

Condition indicated: Minimum filament load not present

Symptoms

- HVPS Front Panel: **FILAMENT LOAD FAULT** LED lights red; **FILAMENT POWER** LED remains green
- FPS Front Panel: **POWER ON** and **HV ON** LEDs are lit
- EBC issues **FPS Gun Ctl Go On Timeout**

For additional information about this fault mode, see Ishikawa Diagram #15.

Possible Cause	Procedure
1. Gun filament burnt out.	1. Check filament and replace if necessary. If OK, proceed to Step 2.
2. Other problems with emitter, gun, HV feedthroughs, and connections to HV feedthroughs.	2. Follow troubleshooting procedures described in gun manual.

Table 5-23 HV Is Switched On but FPS Front Panel HIGH VOLTAGE ON LED Fails To Light**Symptoms**

- HVPS Front Panel: HV switched on, with LEDs indicating nominal HVPS state
- FPS Front Panel: **HIGH VOLTAGE ON** LED is unlit

Possible Cause	Procedure
1. FPS is not powered up.	1. Make sure that FPS is switched on. If switch is on, <i>POWER ON</i> LED is lit, and HV is switched on, proceed to Step 2. If FPS switch is in the ON position but the <i>POWER ON</i> LED is not lit, see Table 5-24.
2. HV IS ON signal is not present at FPSB connector J102.	2. Check pins J102 Pin 1 for the HV IS ON signal. If not present, proceed to Step 3.
3. Fault condition(s) whose investigation requires removal of HVPS top cover	3. Contact Temescal Field Service.

Table 5-24 FPS #1 Is Switched On but Its POWER ON LED Fails To Light**Symptoms**

- HVPS front panel: **FILAMENT POWER** LED on turns red
- FPS #1 front panel: **POWER ON** LED on fails to light when FPS is switched on
- EBC displays **FPS Gun Ctl Go On Timeout** alarm message

For additional information about this fault mode, see Ishikawa Diagram #16.

Possible Cause	Procedure
1. HVPS rear panel connector J1 not supplying 208 V ac power	1. Disconnect FPS power cable from HVPS J1 and check J1 for 208 V ac output. If no voltage or incorrect voltage is indicated, proceed to Step 2. If voltage is correct, skip to Step 4.
2. HVPS rear panel fuses F1 and/or F2 blown.	2. Check fuses and replace as necessary. After replacing either fuse, repeat Step 1 of this procedure. If correct voltage is then detected at J1, reconnect power cable between J1 and FPS #1.
3. Faulty FPS power cable.	3. Reconnect the FPS power cable to J1 and disconnect it from the FPS. Measure the female end of the cable for 208 V ac. Replace cable as necessary.
4. Blown fuses on FPS input power line.	4. Check and replace fuse(s) as necessary, as described in section 5.5.
5. Fault condition(s) whose investigation requires removal of HVPS top cover	5. Contact Temescal Field Service.

Table 5-25 FPS #2 Is Switched On but Its POWER ON LED Fails To Light**Symptoms**

- HVPS front panel: **FILAMENT POWER** LED on turns red
- FPS #2 front panel: **POWER ON** LED on fails to light when FPS is switched on
- EBC: N/A

For additional information about this fault mode, see Ishikawa Diagram #16.

Possible Cause	Procedure
1. HVPS rear panel connector J2 not supplying 208 V ac power	1. Disconnect FPS power cable from HVPS J2 and check J2 for 208 V ac output. If no voltage or incorrect voltage is indicated, proceed to Step 2. If voltage is correct, skip to Step 4.

2. HVPS rear panel fuses F3 and/or F4 blown.	2. Check fuses and replace as necessary. After replacing either fuse, repeat Step 1 of this procedure. If correct voltage is then detected at J2, reconnect power cable between J2 and FPS #1.
3. Faulty FPS power cable.	3. Reconnect the FPS power cable to J2 and disconnect it from the FPS. Measure the female end of the cable for 208 V ac. Replace cable as necessary.
4. Blown fuses on FPS input power line.	4. Check and replace fuse(s) as necessary, as described in section 5.5.
5. Fault condition(s) whose investigation requires removal of HVPS top cover	5. Contact Temescal Field Service.

5.5 FPS Fuse Replacement Procedure

To check the input power fuses and replace them as necessary, follow the instructions provided below.

- | Step | Action |
|------|---|
| 1 | Set the FPS ON/OFF switch to the OFF position. |
| 7 | Switch off the facility breaker providing AC power to the FPS. |
| 8 | Unplug the input power cable from its receptacle on the FPS front panel. |
| 9 | Using a flat-bladed screwdriver, pry open the fuse block's cover as shown in Figure 5-11. |

Figure 5-11 Prying Open the Fuse Block Cover on FPS Front Panel

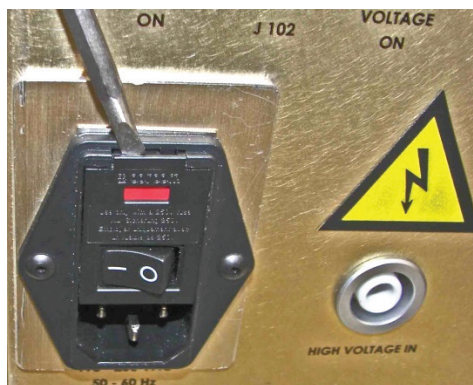

- | | |
|----|--|
| 10 | Using the same screwdriver, pry the fuse block out of its holder, as shown in Figure 5-12. Figure 5-13 shows the fuse block extracted from its holder. |
|----|--|

Figure 5-12 Extracting the Fuse Block from the FPS

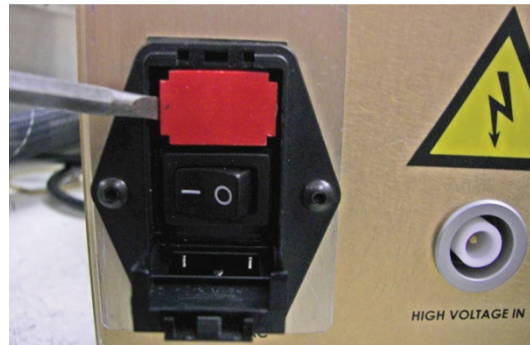

Figure 5-13 Fuse Block Removed from FPS



- 11 Check the fuses and replace them as necessary.
- 12 Push the fuse block all the way into its holder and snap its cover back into place.
- 13 Reconnect the FPS input power cable.
- 14 Switch on facility breaker supplying power to the FPS.
- 15 Set the FPS ON/OFF switch to the ON position.

5.6 Suggested Spare Parts

Table 5-26 Suggested Spare Parts for 208-Volt Units

Component/Assembly	Part Number
Fuse, 6.3 A, 250 VAC	6024-7324-0
Fuse, 1 A, 600 V, CC	6024-7362-0
Diode, Fast REC, 1.2 kV, 17 A to 200 AC	6024-7364-0
Power Entry Module	6024-7312-0
Power Supply, 24 V dc, 2.7 A	6024-7352-0

IGBT, 1600 V, 60 A, *ESD	6024-7330-0
Aux Transformer, 480 VCT In/240 VCT Out	6024-7319-1
Power Choke, 12 kW, 208 V	0620-0933-2
Circuit breaker 40 A, 600 V ac, 3-Pole	6024-7385-0
Rear Fan Assy.	0620-0833-0
Line Filter, 42 A, 12 kW, 208 V	6024-7311-0
HV Transformer, 12 kW, 200 V	6024-7355-2
Display PCA, SLX	0620-5562-0
Interface PCA, SLX	0620-5462-0
HV Output PCA, SLX, 12 kW	0620-5362-1
Regulator PCA, SLX	0620-8762-0
Inverter PCA, SLX, 12 kW, 208 V	0620-5262-3

Table 5-27 Suggested Spare Parts for 400-Volt Units

Component/Assembly	Part Number
Fuse, 6.3 A, 250 VAC	6024-7324-0
Fuse, 1 A, 600 V, CC	6024-7362-0
Diode, Fast REC, 1.2 kV, 17 A to 200 AC	6024-7364-0
Power Entry Module	6024-7312-0
Power Supply, 24 V dc, 2.7 A	6024-7352-0
IGBT, 1600 V, 60 A, *ESD	6024-7330-0
Aux Transformer, 480 VCT In/240 VCT Out	6024-7319-1
Power Choke, 6 kW + 12 kW, 208 V	0620-0933-1
Circuit breaker 30 A, 600 V ac, 3-Pole	6024-7384-0
Rear Fan Assy.	0620-0833-0
Line Filter, 30 A, 480 VAC, 3 PH, Low LKGE	6024-7310-1
HV Transformer, 12 kW, 400 V	6024-7355-1
Display PCA, SLX	0620-5562-0
Interface PCA, SLX	0620-5462-0
HV Output PCA, SLX, 12 kW	0620-5362-1
Regulator PCA, SLX	0620-8762-0
Inverter PCA, SLX, 12 kW, 400 V	0620-5262-1

Appendix A: Pinout Table for HVPS Rear Panel Diagnostic Port (HVPS J3)

Signal Name/ Functional Component	Pin No.	Range	Proportion	Description
Cable Shield	1	N/A	N/A	
Analog Controls (0-10 V dc)				
HV Output Voltage	2	0-10 V dc	0-10 kV dc	Fault at above 10.5 kV dc
HV Output Current	3	0-10 V dc	0-1,000 mA dc	Fault at above 630 mA dc
HV Inverter IGBT Temperature	4	0-10 V dc	0-160° C	Fault at above 67° C
HV Inverter Rail Voltage	5	0-10 V dc	0-1,000 V dc	Fault at below 430 V dc
Arc Counter Integrator	6	0-10 V dc	0-480 S	Fault at above 120 S continuous arcing at above allowable rate
HV Inverter PWM Duty Cycle	7	0-5 V dc	0-100%	
EG Filament Current	8	0-10 V dc	0-50 A ac	
EG Emission Current	9	0-10 V dc	0-2,000 mA dc	
Analog Common	22	N/A		
Digital Controls (0/24 V dc)				
24 V dc Control Power	10	0-10 V dc	0-24 V dc	Fault at below 19.5 V dc
Overtemp. Trip	11	0/24 V dc	0 V dc = Fault	Inverter temperature overload (above 67° C) or cooling fan failure.
External Interlocks	12	0/24 V dc	0 V dc = Fault	
HV Enable (ready)	13	0/24 V dc	0 V dc = Fault	
HV Go ON	14	0/24 V dc	0 V dc = OFF	
Overcurrent Trip	15	0/24 V dc	0 V dc = Fault	HV output current above 105% of nominal (nominal = 600 mA).
Overvoltage Trip	16	0/24 V dc	0 V dc = Fault	HV output voltage above 105% of maximum (maximum = 10 kV).
Arc Counter Active	17	0/24 V dc	0 V dc = Fault	Arc rate or duration exceeds maximum programmed limits (200/second or continuous arcing for more than 120 seconds).
Out of Regulation	18	0/24 V dc	0 V dc = Fault	HV output voltage out of "voltage regulation" mode for over 2 seconds duration.
EG Filament Status	19	0/24 V dc	0 V dc = Fault	Fault = Open filament
EG Filament Power Status	20	0/24 V dc	0 V dc = Fault	Fault = Filament Power Supply OFF
Digital Common	23	N/A	N/A	

